

PanelView Plus 6 Compact Terminals

Catalog Numbers 2711PC-K4M20D8, 2711PC-B4C20D8, 2711PC-B4C20D8-LR, 2711PC-T6M20D8, 2711PC-T6C20D8, 2711PC-T10C4D8



Important User Information

Read this document and the documents listed in the additional resources section about installation, configuration, and operation of this equipment before you install, configure, operate, or maintain this product. Users are required to familiarize themselves with installation and wiring instructions in addition to requirements of all applicable codes, laws, and standards.

Activities including installation, adjustments, putting into service, use, assembly, disassembly, and maintenance are required to be carried out by suitably trained personnel in accordance with applicable code of practice.

If this equipment is used in a manner not specified by the manufacturer, the protection provided by the equipment may be impaired.

In no event will Rockwell Automation, Inc. be responsible or liable for indirect or consequential damages resulting from the use or application of this equipment.

The examples and diagrams in this manual are included solely for illustrative purposes. Because of the many variables and requirements associated with any particular installation, Rockwell Automation, Inc. cannot assume responsibility or liability for actual use based on the examples and diagrams.

No patent liability is assumed by Rockwell Automation, Inc. with respect to use of information, circuits, equipment, or software described in this manual.

Reproduction of the contents of this manual, in whole or in part, without written permission of Rockwell Automation, Inc., is prohibited.

Throughout this manual, when necessary, we use notes to make you aware of safety considerations.



WARNING: Identifies information about practices or circumstances that can cause an explosion in a hazardous environment, which may lead to personal injury or death, property damage, or economic loss.



ATTENTION: Identifies information about practices or circumstances that can lead to personal injury or death, property damage, or economic loss. Attentions help you identify a hazard, avoid a hazard, and recognize the consequence.

IMPORTANT

Identifies information that is critical for successful application and understanding of the product.

Labels may also be on or inside the equipment to provide specific precautions.



SHOCK HAZARD: Labels may be on or inside the equipment, for example, a drive or motor, to alert people that dangerous voltage may be present.



BURN HAZARD: Labels may be on or inside the equipment, for example, a drive or motor, to alert people that surfaces may reach dangerous temperatures.



ARC FLASH HAZARD: Labels may be on or inside the equipment, for example, a motor control center, to alert people to potential Arc Flash. Arc Flash will cause severe injury or death. Wear proper Personal Protective Equipment (PPE). Follow ALL Regulatory requirements for safe work practices and for Personal Protective Equipment (PPE).

This manual contains new and updated information. Changes throughout this revision are marked by change bars, as shown to the right of this paragraph.

New and Updated Information

This table contains the changes made to this revision.

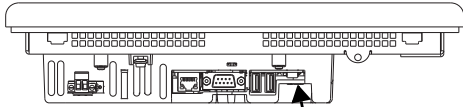
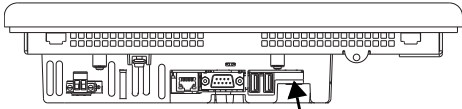
| Topic | Page |
|---|--------------------------|
| Updated the AC voltage and Hz in Table 7 . | 16 |
| The 2711PC-T10C4D8 terminal has been updated. The mini-USB port (type B) has been removed from the new Series B terminal. | 12 13 |
| Removed the mini-USB port (type B) from data and drawings for the Series B 2711PC-T10C4D8 terminal throughout this user manual. | 21 27 30 32 |
|  | 108 109 110 |
| Series A terminal with mini-USB port (no longer available for sale). | 111 112 118 119 |
|  | 122 126 127 |
| Series B terminal without mini-USB port. | 129 143 152 |

Notes:

| | |
|-----------------------------|---|
| Preface | Additional Resources..... 9 |
| | Firmware Upgrades 9 |
| | Chapter 1 |
| Overview | Software Support 12 |
| | PanelView Plus 6 Compact Applications..... 12 |
| | Product Selections 12 |
| | Terminal Features..... 13 |
| | Operator Input 14 |
| | Open versus Closed System 15 |
| | Start-up Options..... 15 |
| | Desktop Access 15 |
| | Product Accessories 16 |
| | Chapter 2 |
| Install the Terminal | Hazardous Locations..... 18 |
| | Mounting Clearances..... 20 |
| | Panel Guidelines 20 |
| | Panel Cutout Dimensions 20 |
| | Product Dimensions 21 |
| | Mount the 400/600 Terminal in a Panel 22 |
| | Mount the 1000 Terminal in a Panel 24 |
| | Remove and Install the Power Terminal Block..... 26 |
| | DC Power Connections 28 |
| | Initial Startup..... 31 |
| | Reset Terminal 31 |
| | Chapter 3 |
| Configuration Mode | Access Configuration Mode..... 33 |
| | Terminal Settings 36 |
| | Load and Run Application..... 38 |
| | Start-up Options..... 39 |
| | Desktop Access 42 |
| | Communication Setup 46 |
| | Ethernet Network Connections..... 48 |
| | File Management..... 52 |
| | Display Settings..... 55 |
| | Input Device Settings..... 57 |
| | Configure Print Options 60 |
| | Check Integrity of Application Files 62 |
| | Configure Diagnostics..... 63 |
| | View and Clear the System Event Log..... 64 |
| | System Information 64 |
| | Enable or Disable the Alarm Display..... 66 |

| | | |
|---------------------------------------|---|-----|
| | Time and Date Settings | 67 |
| | Regional Settings | 69 |
| | Font Linking | 72 |
| | Chapter 4 | |
| Windows CE Operating System | Windows CE 6.0 Features | 73 |
| | Windows Explorer | 76 |
| | Taskbar | 76 |
| | Input Panels | 76 |
| | Windows Control Panel | 77 |
| | Backup and Restore | 78 |
| | Hardware Monitor | 81 |
| | Keypad Properties | 83 |
| | Touch Properties | 83 |
| | Display Properties | 84 |
| | Logo Manager | 86 |
| | System Information | 87 |
| | User Accounts | 90 |
| | Services | 91 |
| | Network Server Configuration | 92 |
| | Printer Support | 101 |
| | PDF Reader | 104 |
| | Chapter 5 | |
| Install and Replace Components | Required Tools | 107 |
| | Install or Replace the Logic Module | 108 |
| | Install or Replace a Communication Module | 109 |
| | Replace the Display Module | 111 |
| | Replace the Bezel | 112 |
| | Replace the Backlight | 114 |
| | Replace the Battery | 117 |
| | Install the AC Power Supply Module | 119 |
| | Remove the Product ID Label | 122 |
| | Load an SD Card | 122 |
| | Clean the Display | 123 |
| | Chapter 6 | |
| Connections and Communication | USB Ports | 126 |
| | Ethernet Connection | 127 |
| | Serial Connection | 129 |
| | Controller Connections | 132 |
| | Chapter 7 | |
| Firmware Upgrades | Terminal Firmware | 135 |
| | Download Firmware Files | 136 |

| | | |
|---|--|-----|
| | Firmware Upgrade Wizard..... | 136 |
| | Upgrading Terminal Firmware from a Storage Device..... | 137 |
| | Upgrade Terminal Firmware over the Network..... | 140 |
| | Chapter 8 | |
| Troubleshooting | Status Indicators | 143 |
| | Terminal Does Not Start Properly..... | 144 |
| | Start-up Messages and Codes..... | 145 |
| | Check Terminal Components | 147 |
| | Ethernet Connection..... | 148 |
| | Program Launcher ActiveX Control..... | 149 |
| | Application Does Not Run | 149 |
| | Configuration Mode Access..... | 149 |
| | File System Errors..... | 150 |
| | Advanced Diagnostics | 150 |
| | Maintenance Operations | 151 |
| | Appendix A | |
| Fonts Resident on Terminal Index | True Type Fonts | 155 |
| | | 157 |

This manual describes how to install, configure, operate, and troubleshoot the PanelView™ Plus 6 Compact terminals. It does not provide procedures on how to create applications that run on the terminal.

You also need to do the following:

- Use FactoryTalk® View Studio for Machine Edition to create a human-machine interface (HMI) application to run in the terminal.
- Create ladder logic to interact with the HMI application.

Additional Resources

These documents contain additional information concerning related products from Rockwell Automation.

| Resource | Description |
|---|---|
| PanelView Plus Specifications Technical Data, publication 2711P-TD005 | Provides technical specifications, environmental specifications, and certifications for the PanelView Plus Compact terminals. |
| Industrial Automation Wiring and Grounding Guidelines, publication 1770-4.1 | Provides general guidelines for installing a Rockwell Automation® industrial system. |
| Product Certifications website, http://www.ab.com | Provides declarations of conformity, certificates, and other certification details. |

You can view or download publications at <http://www.rockwellautomation.com/literature/>. To order paper copies of technical documentation, contact your local Allen-Bradley distributor or Rockwell Automation sales representative.

This product ships with these items:

- Terminal with FactoryTalk View Machine Edition runtime software installed and activated
- Product information
- Mounting levers for panel installation
- Panel cutout template

Firmware Upgrades

For the latest firmware upgrades and other downloads for PanelView Plus 6 Compact terminals, go to <http://www.rockwellautomation.com/support> and click Firmware Updates.

Notes:

Overview

| Topic | Page |
|---------------------------------------|------|
| Software Support | 12 |
| PanelView Plus 6 Compact Applications | 12 |
| Product Selections | 12 |
| Terminal Features | 13 |
| Operator Input | 14 |
| Open versus Closed System | 15 |
| Start-up Options | 15 |
| Desktop Access | 15 |
| Product Accessories | 16 |

PanelView Plus 6 Compact terminals (400/600/1000) are similar to the PanelView Plus 6 (400/600) terminals but with limited hardware and software functions. Major differences of the PanelView Plus 6 Compact terminals include the following items:

- Serial and Ethernet communication only
- Connection to a single logic controller by using either RSLinx® Enterprise or KEPServer Enterprise software, not both
- Limited number of displays and alarms in FactoryTalk View Machine Edition (ME) application and runtime software
- Primary HMI for CompactLogix™ controllers

TIP Applications created for PanelView Plus 6 Compact terminals are referred to as Compact Machine Edition applications. They run on PanelView Plus 6 and PanelView Plus 6 Compact terminals. You cannot run a Machine Edition application created for a PanelView Plus 6 terminal on a PanelView Plus 6 Compact terminal.

Software Support

[Table 1](#) lists software supported by the terminals.

Table 1 - PanelView Plus 6 Compact Software Support

| Software | Description | Version |
|---|---|---------------|
| FactoryTalk View Machine Edition Station | Runtime environment for FactoryTalk View Machine Edition .mer applications. Machine Edition Station is preloaded on each terminal and does not require FactoryTalk View activation. | 6.10 or later |
| FactoryTalk View Studio for Machine Edition | Configuration software for developing HMI applications that run on PanelView Plus 6 Compact terminals. RSLinx Enterprise software is included with FactoryTalk View Studio software and loaded during installation. | 6.10 or later |
| Windows CE 6.0 operating system | All terminals run the Windows CE 6.0 operating system with an open or closed desktop environment. Other supported features include these items: <ul style="list-style-type: none"> • FTP server • VNC client/server • ActiveX controls⁽¹⁾ • Third-party device support • Adobe PDF reader | 6.0 |

(1) Refer to [Display FactoryTalk View ME Station Information on page 66](#) for a list of ActiveX controls loaded on a terminal.

PanelView Plus 6 Compact Applications

PanelView Plus 6 Compact Machine Edition applications are restricted to a subset of the functions on the PanelView Plus 6 terminals:

- Maximum of 25 screens.
- Maximum of 200 alarm messages.
- One connection or shortcut to a single controller by using either RSLinx Enterprise or KEPServer Enterprise software.
- Only Serial and Ethernet communication are supported.

If using RSLinx Enterprise software, only serial DF1, serial DH-485, and Ethernet drivers are supported.

Product Selections

[Table 2](#) lists the catalog numbers of the PanelView Plus 6 Compact terminals.

Table 2 - PanelView Plus 6 Compact Terminals

| Cat. Nos. | Display | | Input Type | Communication Ports | | USB Ports | | Power |
|-------------------|----------|-----------|------------------|---------------------|--------|-----------|--------|-------|
| | Size | Type | | Ethernet | RS-232 | Host | Device | |
| 2711PC-K4M20D8 | 3.5-in. | Grayscale | Keypad | • | • | • | • | DC |
| 2711PC-B4C20D8 | | Color | Keypad and Touch | • | • | • | • | |
| 2711PC-B4C20D8-LR | | | | • | • | • | • | |
| 2711PC-T6M20D8 | 5.7-in. | Grayscale | Touch | • | • | • | • | |
| 2711PC-T6C20D8 | | Color | | • | • | • | • | |
| 2711PC-T10C4D8 | 10.4 in. | Color | Touch | • | • | • | | |

Terminal Features

The PanelView Plus 6 Compact 400, 600, and 1000 terminals are fixed configurations that do not support modular components.

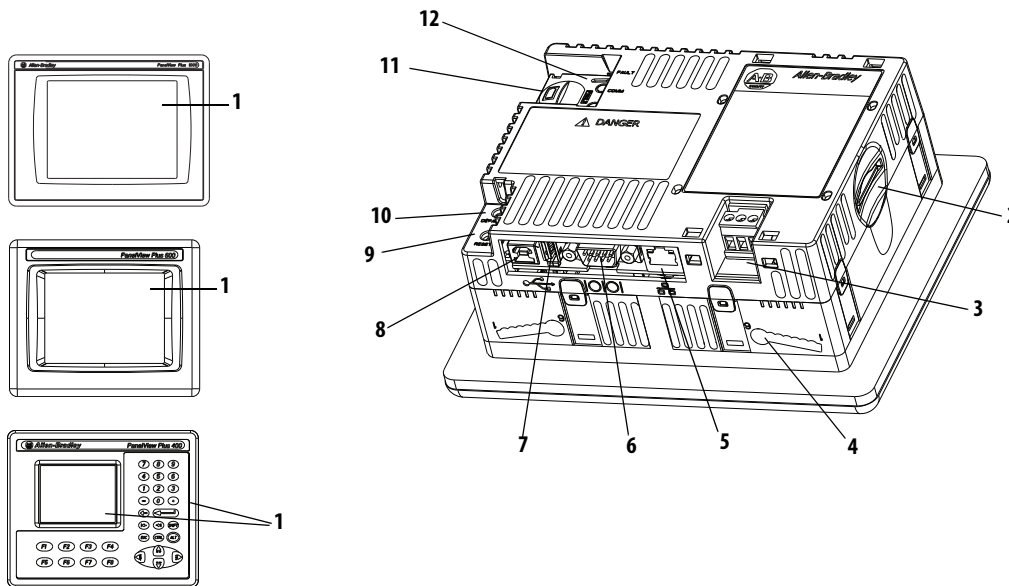

Table 3 - PanelView Plus 6 Compact Terminal Components

| Item | Component |
|------|--|
| 1 | 3.5, 5.7, or 10.4-in. grayscale or color display with one of these operator input options: <ul style="list-style-type: none"> Keypad Touch screen Combination keypad and touch screen |
| 2 | Secure Digital (SD) card slot for external storage |
| 3 | DC power input, non-isolated 24V DC nom (18...30V DC) |
| 4 | Mounting slots (four) |
| 5 | Ethernet port for controller communication, 10/100Base-T, Auto MDI/MDI-X |
| 6 | RS-232 serial port for controller communication, printing, or file transfers |
| 7 | One USB 2.0 high-speed (type A) host port for attaching USB peripherals including mouse, keyboard, printer, and USB drives that are hot-swappable in nonhazardous locations |
| 8 | One USB 2.0 high-speed (type B) device port for connecting a host computer (only 400 and 600 terminals) |
| 9 | Reset switch to reset the terminal without having to power off and on |
| 10 | Default switch to access maintenance operations such as restoring factory defaults |
| 11 | Battery compartment |
| 12 | Indicators provide communication and fault status |

Operator Input

The terminals feature grayscale or color LCD displays with keypad, touch screen, or keypad and touch-screen input.

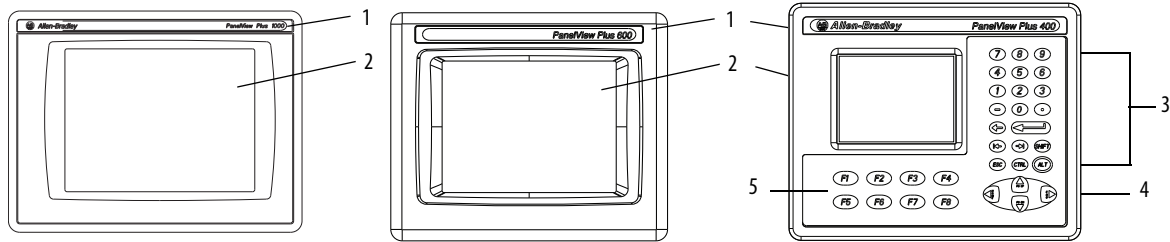

Table 4 - Display and Operator Input Features

| Item | Feature | Description |
|------|------------------------------|--|
| 1 | Product label | Product identification label can be replaced with custom label. |
| 2 | Display/touch screen | Color or grayscale display with or without a resistive, 4-wire, touch screen (catalog number dependent) |
| 3 | Numeric keypad | 0 . . 9, Backspace, Enter, Left and Right Tab, Esc, Shift, Ctrl, Alt keys |
| 4 | Navigation keys | Use arrow keys for navigation. Use Alt+arrow to initiate these functions: <ul style="list-style-type: none"> • Alt+left arrow (Home), Alt+right arrow (End) • Alt+up arrow (Page Up), Alt+down arrow (Page Down) |
| 5 | Function keys F1 . . . F8 | Keys that can be configured in the application to perform operations. For example, F1 can be configured to navigate to another screen. |



ATTENTION: Use a finger or gloved-finger to operate the keypad. To operate the touch screen, use a finger, gloved-finger, or plastic stylus with a minimum tip radius of 1.3 mm (0.051 in.). If you use any other object or tool you can damage the keypad or touch screen.



ATTENTION: Do not carry out multiple operations simultaneously. Doing so can result in unintended operation:

- Touch only one operating element on the screen with one finger at one time.
- Press only one key on the terminal at one time.

Open versus Closed System

The terminals can be configured to run an open or closed desktop environment:

- An open system launches the Windows Explorer desktop on startup. The system is configurable via the control panel and supports Windows operations.
- A closed system launches a FactoryTalk View Machine Edition application on startup and restricts access to the Windows Explorer desktop.

All terminals are shipped as closed systems restricting access to the desktop. The first time you start the system, the terminal launches FactoryTalk View ME Station Configuration mode. At this point, you can change the start-up option to allow desktop access.

Start-up Options

You can configure the terminal to perform one of three actions at startup:

- Launch a FactoryTalk View Machine Edition HMI application.
- Launch the FactoryTalk View Machine Edition Configuration mode of the terminal where you load and run applications, configure start-up options and terminal settings, and enable or disable desktop access.
- Launch the Windows Explorer desktop.

The factory default state and start-up option following a firmware upgrade is to launch the terminal in Configuration mode. Refer to [Start-up Options on page 39](#) for details on how to change the start-up option.

Desktop Access

Any of the terminals can be configured to allow or restrict desktop access. From the desktop, you can perform system and control panel operations, or run third-party applications. You can also enable temporary access to perform specific tasks, then disable access to prevent unauthorized changes.

TIP All terminals are shipped with desktop access disabled.

Refer to [Desktop Access on page 42](#) for details on how to modify desktop access.

Product Accessories

Table 5 through Table 10 lists accessories for the terminals.

Table 5 - Secure Digital (SD) Cards

| Cat. No. | Terminal Model | Description |
|------------|----------------|-------------------------------|
| 1784-SD1 | All terminals | 1 GB SD card |
| 1784-SD2 | | 2 GB SD card |
| 2711C-RCSD | | USB to SD adapter for SD card |

Table 6 - Cables

| Cat. No. | Terminal Model | Description | Length |
|-------------------------------|----------------|--|--------------|
| 6189V-USBCBL2 | 400 or 600 | Programming cable that connects the USB device port of the terminal to a USB host port of a computer | 1.8 m (6 ft) |
| 2711C-CBL-UU02 ⁽¹⁾ | 1000 | Programming cable that connects the USB device port of the terminal to a USB host port of a computer | 2 m (6.5 ft) |

(1) Only for Series A terminals with a mini-USB port, type B.

Table 7 - Power Supply and Power Terminal Blocks

| Cat. No. | Terminal Model | Description | Quantity |
|---------------|----------------|--|----------|
| 2711P-RSACDIN | 400 and 600 | DIN-rail power supply, AC-to-DC, 100...240V AC, 50...60 Hz | 1 |
| 2711P-6RSA | | AC module converts a DC terminal to AC power | 1 |
| 2711-TBDC | | DC power terminal block | 10 |
| 2711P-RTBAC3 | 1000 | AC power terminal block | 10 |
| 2711P-RTBDC2 | | DC power terminal block | 10 |

Table 8 - Replacement Battery

| Cat. No. | Terminal Model | Description |
|--------------|----------------|---|
| 2711P-RY2032 | All terminals | Replacement CR2032 coin-cell equivalent battery |

Table 9 - Antiglare Overlays

| Cat. No. ⁽¹⁾ | Terminal Model | Operator Input | | |
|-------------------------|------------------------|----------------|-------|-----------|
| | | Keypad | Touch | Key/Touch |
| 2711P-RGB4 | 400 grayscale or color | • | | • |
| 2711P-RGT6 | 600 grayscale or color | | • | |
| 2711P-RGT10 | 1000 color | | • | |

(1) Three overlays are shipped with each catalog number.

Table 10 - Mounting Hardware

| Cat. No. | Terminal Model | Description | Quantity |
|------------|----------------|-----------------------------|----------|
| 2711P-RTFC | 400 and 600 | Replacement mounting levers | 8 |
| 2711P-RTMC | 1000 | Replacement mounting clips | 8 |

Install the Terminal

| Topic | Page |
|--|------|
| Required Circuit Parameters for USB Peripheral Devices | 19 |
| Mounting Clearances | 20 |
| Panel Guidelines | 20 |
| Panel Cutout Dimensions | 20 |
| Product Dimensions | 21 |
| Mount the 400/600 Terminal in a Panel | 22 |
| Mount the 1000 Terminal in a Panel | 24 |
| Remove and Install the Power Terminal Block | 26 |
| DC Power Connections | 28 |
| Initial Startup | 31 |
| Reset Terminal | 31 |



ATTENTION: Environment and Enclosure

This equipment is intended for use in a Pollution Degree 2 industrial environment, in overvoltage Category II applications (as defined in IEC 60664-1), at altitudes up to 2000 m (6561 ft) without derating.

The terminals are intended for use with programmable logic controllers. Terminals that are AC powered must be connected to the secondary of an isolating transformer.

This equipment is considered Group 1, Class A industrial equipment according to IEC CISPR 11. Without appropriate precautions, there may be difficulties with electromagnetic compatibility in residential and other environments due to conducted or radiated disturbances.

Korean Radio Wave Suitability Registration - When so marked this equipment is registered for Electromagnetic Conformity Registration as business equipment (A), not home equipment. Sellers or users are required to take caution in this regard.

This equipment is supplied as open-type equipment. It must be mounted within an enclosure that is suitably designed for those specific environmental conditions that will be present and appropriately designed to prevent personal injury resulting from accessibility to live parts. The interior of the enclosure must be accessible only by the use of a tool. The terminals meet specified NEMA, UL type, and IEC ratings only when mounted in a panel or enclosure with the equivalent rating. Subsequent sections of this publication may contain additional information regarding specific enclosure type ratings that are required to comply with certain product safety certifications.

In addition to this publication, see the following:

- Industrial Automation Wiring and Grounding Guidelines, publication [1770-4.1](#), for additional installation requirements
- NEMA 250 and IEC 60529, as applicable, for explanations of the degrees of protection provided by different types of enclosure



ATTENTION: Wiring and Safety Guidelines



Use publication NFPA 70E, Electrical Safety Requirements for Employee Workplaces, IEC 60364 Electrical Installations in Buildings, or other applicable wiring safety requirements for the country of installation when wiring the devices. In addition to the NFPA guidelines, here are some other guidelines to follow:

- Connect the device and other similar electronic equipment to its own branch circuit.
- Protect the input power by a fuse or circuit breaker rated at no more than 15 A.
- Route incoming power to the device by a separate path from the communication lines.
- Cross power and communication lines at right angles if they must cross.
- Communication lines can be installed in the same conduit as low-level DC I/O lines (less than 10V).
- Shield and ground cables appropriately to avoid electromagnetic interference (EMI). Grounding minimizes noise from EMI and is a safety measure in electrical installations.

For more information on grounding recommendations, refer to the National Electrical Code published by the National Fire Protection Association.

Hazardous Locations

North American Hazardous Location Approval

| The following information applies when operating this equipment in hazardous locations. | Les informations suivantes s'appliquent pour les équipements utilisés dans des environnements dangereux. |
|--|--|
| <p>When marked, these products are suitable for use in Class I, Division 2, Groups A, B, C and D; Class II, Division 2, Groups F and G; Class III hazardous locations and nonhazardous locations only. Each product is supplied with markings on the rating nameplate indicating the hazardous location temperature code. When combining products within a system, the most adverse temperature code (lowest "T" number) may be used to help determine the overall temperature code of the system. Combinations of equipment in your system are subject to investigation by the local Authority Having Jurisdiction at the time of installation.</p> | <p>Les produits marqués "CL I, DIV 2, GP A, B, C, D" ne conviennent qu'à une utilisation en environnements de Classe I, Division 2, Groupes A, B, C et D ; Classe II, Division 2, Groupes F et G ; Classe III dangereux et non dangereux. Chaque produit est livré avec des marquages sur sa plaque d'identification qui indiquent le code de température pour les environnements dangereux. Lorsque plusieurs produits sont combinés dans un système, le code de température le plus défavorable (code de température le plus faible) peut être utilisé pour déterminer le code de température global du système. Les combinaisons d'équipements dans le système sont sujettes à inspection par les autorités locales qualifiées au moment de l'installation.</p> |
|  <p>WARNING: EXPLOSION HAZARD</p> <ul style="list-style-type: none"> • Do not disconnect equipment unless power has been removed or the area is known to be nonhazardous. • Do not disconnect connections to this equipment unless power has been removed or the area is known to be nonhazardous. • Substitution of components may impair suitability for Class I, Division 2. • Peripheral equipment must be suitable for the location in which it is used. • The battery or real-time clock module in this product must only be changed in an area known to be nonhazardous. • All wiring must be in accordance with Class I, Division 2, Class II, Division 2, or Class III wiring methods of Articles 501, 502 or 503, as appropriate, of the National Electrical Code and/or in accordance with Section 18-1J2 of the Canadian Electrical Code, and in accordance with the authority having jurisdiction. • When used in Class II and Class III hazardous locations these products must be installed in a dust tight enclosure in accordance with Articles 502 and 503 of the National Electrical Code. |  <p>AVERTISSEMENT : RISQUE D'EXPLOSION</p> <ul style="list-style-type: none"> • Couper le courant ou s'assurer que l'environnement est classé non dangereux avant de débrancher l'équipement. • Couper le courant ou s'assurer que l'environnement est classé non dangereux avant de débrancher les connecteurs. • La substitution de composants peut rendre cet équipement inadapté à une utilisation en environnement de Classe I, Division 2 • Les équipements périphériques doivent s'adapter à l'environnement dans lequel ils sont utilisés. • La batterie ou le module de l'horloge en temps réel de ce produit doit être changé(e) uniquement dans un environnement classé sans risque. • Tous les systèmes de câblage doivent être de Classe I, Division 2, Classe II, Division 2, ou Classe III conformément aux méthodes de câblage indiquées dans les Articles 501, 502 ou 503 du National Electrical Code (Code Electrique National) et/ou conformément à la Section 18-1J2 du Canadian Electrical Code (Code Electrique Canadien), et en fonction de l'autorité de juridiction. • Quand ces produits sont utilisés dans des environnements dangereux de Classe II et Classe III, ils doivent être installés dans une enceinte étanche aux poussières conformément aux Articles 502 et 503 du Code Electrique National (National Electrical Code). |

The terminals have a temperature code of T4 when operating in a 55 °C (131 °F) maximum ambient temperature. Do not install product in environments where atmospheric gases have ignition temperatures less than 135 °C (275 °F).

Required Circuit Parameters for USB Peripheral Devices

This product contains a USB host port that complies with hazardous location environments. Field-wiring compliance requirements are provided in compliance with the National Electrical Code, Article 500.

Figure 1 - PanelView Plus 6 Compact Terminals Control Drawing

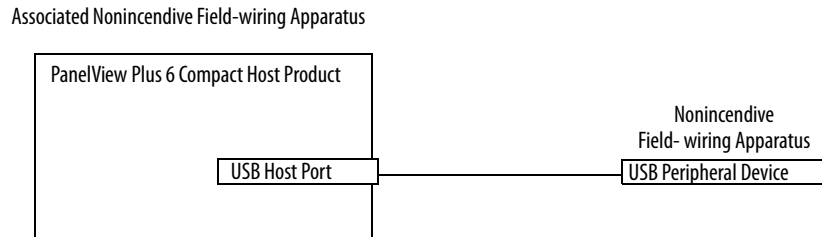

PanelView Plus 6 Compact terminals provide one separately powered USB host port. [Table 11](#) defines the circuit parameters of the USB host port.

Table 11 - Circuit Parameters for USB Host Ports

| Parameter | Value | Parameter Definition | |
|---------------|------------|--|---|
| $V_{oc(USB)}$ | 5.25V DC | Open circuit voltage of the host USB port. The maximum applied voltage rating, $V_{max(Peripheral)}$, of each USB peripheral device must be greater than or equal to $V_{oc(USB)}$. | $V_{max(Peripheral)} \geq V_{oc(USB)}$, as appropriate |
| $I_{sc(USB)}$ | 1.68 A | Maximum output current of the host USB port. The maximum current, $I_{max(Peripheral)}$, that each USB peripheral device can be subjected must be greater than or equal to $I_{sc(USB)}$. | $I_{max(Peripheral)} \geq I_{sc(USB)}$ |
| $C_a(USB)$ | 10 μ F | This value is the maximum total capacitance that can be connected to the USB host port. The total capacitance of the USB peripheral device and its associated cable must not exceed the indicated value. The maximum total capacitance, $C_i(Peripheral)$, and cable capacitance of each separate USB peripheral device must be less than or equal to $C_a(USB)$. | $C_i(Peripheral) + C_{cable(USB)} \leq C_a(USB)$ |
| $L_a(USB)$ | 15 μ H | This value is the maximum total inductance that can be connected to the USB host port. The total inductance of the USB peripheral device and its associated cable must not exceed the indicated value. The maximum total inductance, $L_i(Peripheral)$, and cable inductance of the separate USB peripheral device must be less than or equal to $L_a(USB)$. | $L_i(Peripheral) + L_{cable} \leq L_a(USB)$ |

Application Information

Per the National Electrical Code, the circuit parameters of associated field-wiring apparatus for use in hazardous locations must be coordinated with the host product such that their combination remains nonincendive. PanelView Plus 6 Compact terminals and the USB peripheral devices must be treated in this manner.

The USB peripheral devices and their associated cabling must have circuit parameters with the limits given in [Table 11](#) for them to remain nonincendive when used with the PanelView Plus 6 Compact USB host port.

If cable capacitance and inductance are not known, use the following values from ANSI/ISA-RP 12.06.01-2003:

$$C_{cable} = 197 \text{ pF/m (60 pF/ft)}$$

$$L_{cable} = 0.7 \text{ } \mu\text{H/m (0.20 } \mu\text{H/ft)}$$

Nonincendive field-wiring must be wired and separated in accordance with 501.10(B)(3) of the National Electrical Code (NEC) ANSI/NFPA 70 or other local codes as applicable. This associated nonincendive field-wiring apparatus has not been evaluated for use in combination with another associated nonincendive field-wiring apparatus.

Mounting Clearances

Plan for adequate space around the terminal, inside the enclosure, for ventilation and cabling. Consider heat produced by other devices in the enclosure. The ambient temperature around the terminal must be 0...55 °C (32...131 °F).

Table 12 - Minimum Required Clearances

| Product Area | Minimum Clearance |
|--------------|-------------------------------|
| Top | 51 mm (2 in.) |
| Bottom | 102 mm (4 in.) ⁽¹⁾ |
| Side | 25 mm (1 in.) ⁽¹⁾ |
| Back | 0 mm (0 in.) |

(1) A clearance of 102 mm (4 in.) is sufficient on the side of the terminal to insert and remove an SD card, and on the bottom of the terminal for connections.

Panel Guidelines

The terminals are panel-mounted devices intended to mount in the door or wall of a NEMA rated, UL Type rated, or IP rated enclosure:

- Supporting panels must have a mounting thickness of 1.5...4.8 mm (0.060...0.188 in.).
- The material strength and stiffness of the panel must be sufficient to hold the terminal and maintain an appropriate seal against water and dust.
- The panel surface must be flat and free of imperfections to maintain an adequate seal and NEMA and UL Type ratings.

Panel Cutout Dimensions

Use the full-size template shipped with your product to mark the cutout dimensions.

Table 13 - Panel Cutout Dimensions

| Terminal Type | Input Type | Height, mm (in.) | Width, mm (in.) |
|---------------|------------------------|------------------|-----------------|
| 400 | Keypad or keypad/touch | 123 (4.86) | 156 (6.15) |
| 600 | Touch | 123 (4.86) | 156 (6.15) |
| 1000 | Touch | 224 (8.8) | 305 (12.00) |

Product Dimensions

Figure 2 through Figure 4 provide product dimensions.

Figure 2 - PanelView Plus 6 Compact - 400 Keypad or Keypad/Touch

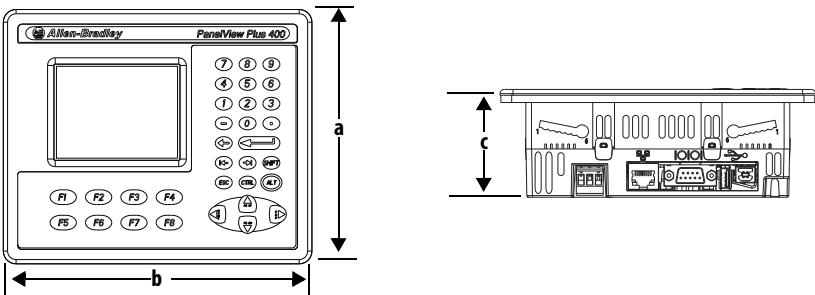

Figure 3 - PanelView Plus 6 Compact - 600 Touch

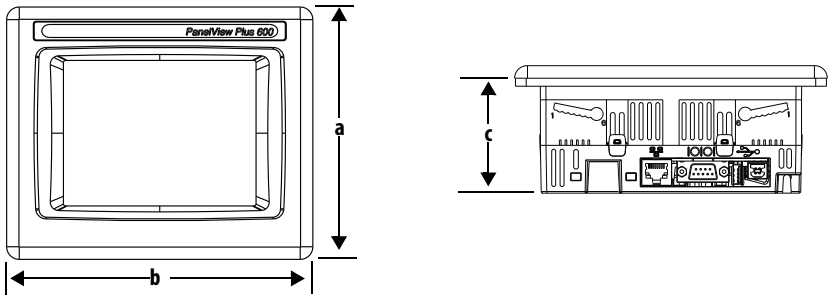

Figure 4 - PanelView Plus 6 Compact - 1000 Touch

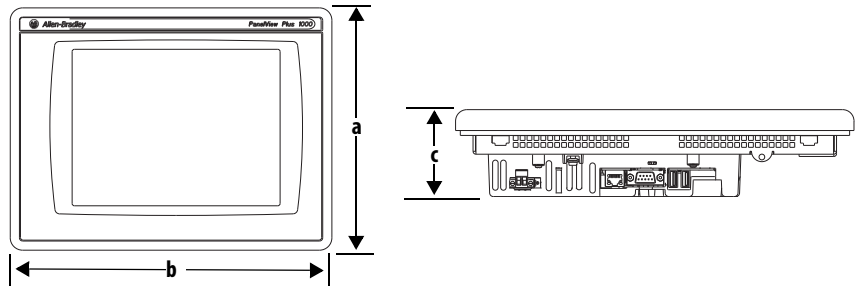

Table 14 - PanelView Plus 6 Compact - 400/600/1000 Product Dimensions

| Terminal Size | Input Type | Height (a) mm (in.) | Width (b) mm (in.) | Depth (c) mm (in.) |
|---------------|------------------------|------------------------|-----------------------|-----------------------|
| 400 | Keypad or keypad/touch | 152 (6.0) | 185 (7.28) | 60 (2.35) |
| 600 | Touch | 152 (6.0) | 185 (7.28) | 68 (2.68) |
| 1000 | Touch | 248 (9.77) | 329 (12.97) | 83 (3.27) |

Mount the 400/600 Terminal in a Panel

The terminals are designed for single-person installation. No tools are required except for those needed to make the panel cutout.

Four mounting levers secure the terminal to the panel. The levers insert into the mounting slots on the top and bottom of the terminal.

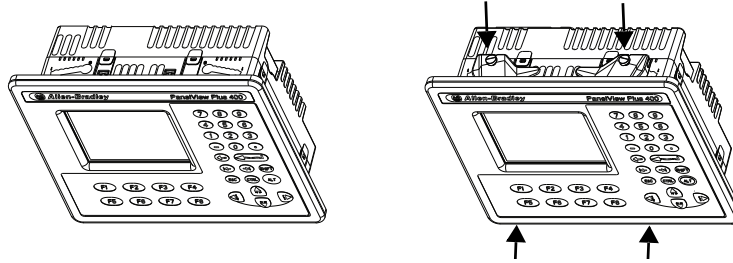

Each mounting slot has six notches with alignment marks that are locking positions for a lever. The thickness of the panel where you mount the terminal determines the locking position required to maintain the NEMA/UL Type seal.

Table 15 - Lever Locking Positions

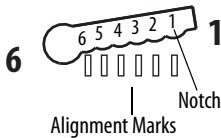
| Mounting Slot | Lever Lock Position | Panel Thickness Range | Typical Gauge |
|--|---------------------|------------------------------------|---------------|
| Orientation of Slot Varies  | 1 | 1.50...2.01 mm (0.060...0.079 in.) | 16 |
| | 2 | 2.03...2.64 mm (0.080...0.104 in.) | 14 |
| | 3 | 2.67...3.15 mm (0.105...0.124 in.) | 12 |
| | 4 | 3.17...3.66 mm (0.125...0.144 in.) | 10 |
| | 5 | 3.68...4.16 mm (0.145...0.164 in.) | 8/9 |
| | 6 | 4.19...4.80 mm (0.165...0.188 in.) | 7 |

Follows these steps to mount the terminal in a panel.



ATTENTION: Disconnect all electrical power from the panel before making the panel cutout.

Make sure the area around the panel cutout is clear and that the panel is clean of any debris, oil, or other chemicals.

Make sure metal cuttings do not enter any components already installed in the panel and that the edges of the cutout have no burrs or sharp edges.

Failure to follow these warnings can result in personal injury or damage to panel components.

1. Cut an opening in the panel by using the cutout template shipped with the terminal or the cutout dimensions on [page 20](#).
2. Verify the sealing gasket is present on the terminal.

This gasket forms a compression-type seal. Do not use sealing compounds.

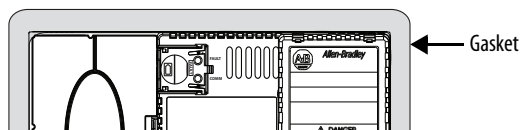

- Place the terminal in the panel cutout.

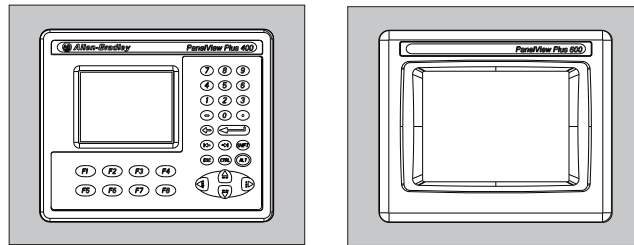

- Insert all mounting levers into the mounting slots on the terminal.
Slide each lever until the flat side of the lever touches the panel surface.

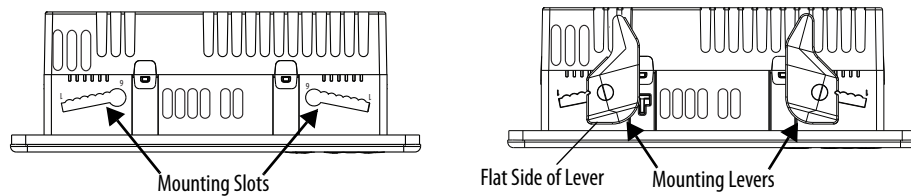

- When all levers are in place, slide each lever an additional notch or two until you hear a click.
Refer to [Table 15 on page 22](#) as a guide to determine the locking positions for your panel thickness.

- Rotate each lever in the direction indicated until it is in the final position.

TIP Levers rotate in same direction on top and bottom of terminal.

Follow the appropriate locking sequence for the optimal terminal fit.

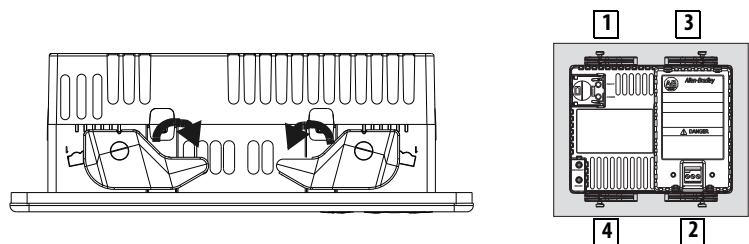
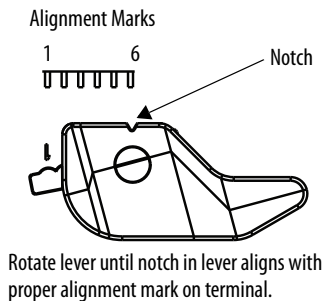

- Inspect all levers to verify that they are in the correct and same locked position.



ATTENTION: All levers must be locked to provide an adequate gasket seal between the terminal and the panel. Rockwell Automation assumes no responsibility for water or chemical damage to the terminal or other equipment within the enclosure because of improper installation.

Mount the 1000 Terminal in a Panel

Four mounting clips secure the 1000 terminal in a panel. Tools required for installation include panel cutout tools, a small, slotted screwdriver, and a torque wrench for tightening the mounting clips.



ATTENTION: Disconnect all electrical power from the panel before making the panel cutout.

Make sure the area around the panel cutout is clear and that the panel is clean of any debris, oil, or other chemicals.

Make sure metal cuttings do not enter any components already installed in the panel and that the edges of the cutout have no burrs or sharp edges.

Failure to follow these warnings can result in personal injury or damage to panel components.

Follow these steps to mount the terminal in a panel.

1. Cut an opening in the panel by using the panel cutout template shipped with the terminal or the cutout dimensions on [page 20](#).
2. Verify the terminal sealing gasket is properly positioned on the terminal.

This gasket forms a compression type seal. Do not use sealing compounds.

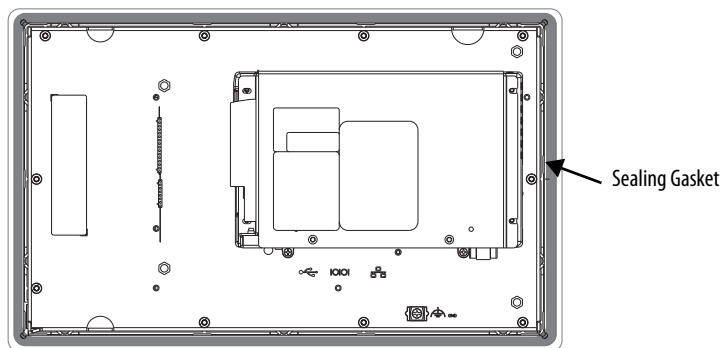

Be careful not to pinch the legend strip during installation.

- Place the terminal in the panel cutout.

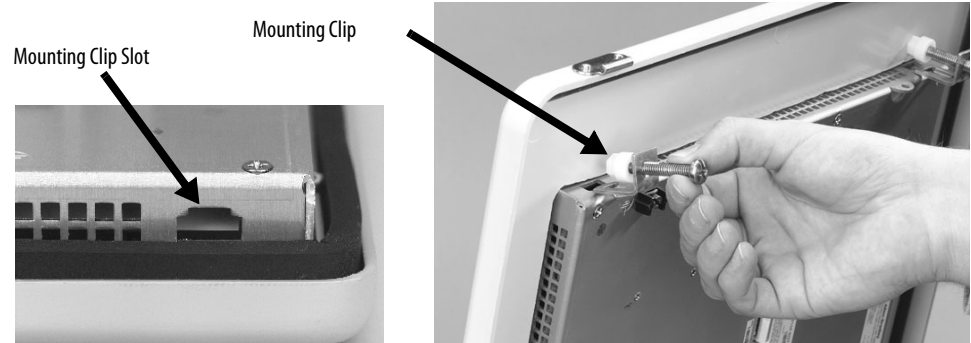

- Slide the ends of the mounting clips into the slots on the terminal.
- Tighten the mounting clip screws by hand until the gasket seal contacts the mounting surface uniformly.



- Tighten the mounting clips screws to a torque of 0.90...1.1 N•m (8...10 lb•in) by using the specified sequence, making sure not to overtighten.

| | |
|----------------------------|---|
| 1 | 4 |
| Torque Sequence 4 Clips | |
| 3 | 2 |



ATTENTION: Tighten the mounting clips to the specified torque to provide a proper seal and to prevent damage to the product. Rockwell Automation assumes no responsibility for water or chemical damage to the product or other equipment within the enclosure because of improper installation.

Remove and Install the Power Terminal Block

The terminals are shipped with a power terminal block installed. You can remove the terminal block for ease of installation, wiring, and maintenance.



WARNING: Explosion Hazard

If you connect or disconnect wiring while the power is on, an electrical arc can occur. This could cause an explosion in hazardous location installations. Be sure that power is removed and the area is nonhazardous before proceeding.

Failure to remove power can result in electrical shock or damage to the terminal.

The power terminal block is not intended for daisy chaining power.

Use a 0.6 x 3.5 mm flat-blade screwdriver for terminal block wiring.

Table 16 - Wire Specifications for Power Input Terminal Block

| Terminal | Wire Type | Dual-wire Size ⁽¹⁾ | Single-wire Size | Strip Length | Screw Torque |
|----------|--|--|--|-----------------|----------------------------------|
| 400, 600 | Stranded or solid Cu 90 °C (194 °F) | 0.3...1.3 mm ² 22...16 AWG | 0.3...2.1 mm ² (22...14 AWG) | 7 mm (0.28 in.) | 0.45...0.56 N·m (4...5 lb·in) |
| 1000 | | | | | 0.56...0.90 N·m (5...8 lb·in) |

(1) Two-wire max per terminal.

400 and 600 Terminals

Follow these steps to remove the terminal block.

1. Insert the tip of a small, flat-blade screwdriver into the terminal block access slot.
2. Gently pry the terminal block to rotate it away from the terminal; this releases the locking mechanism.

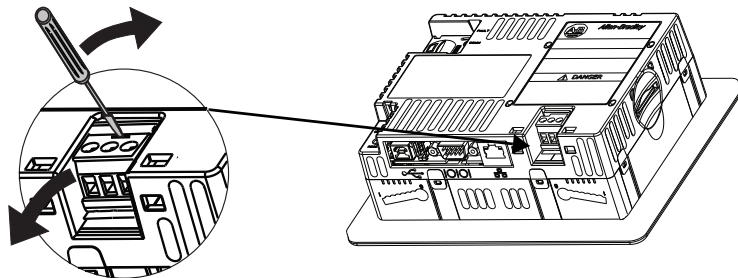

Follow these steps to install the terminal block.

1. Press the terminal block base in first with the block leaning outward.

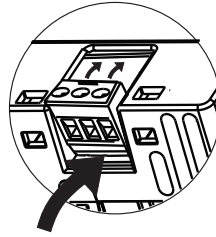

2. Gently push the top of the terminal block to rotate it into place.
The terminal block snaps into place when seated.

1000 Terminals

Follow these steps to remove the terminal block from a 1000 terminal.

1. Loosen the two screws that secure the terminal block.
2. Gently pull the terminal block away from the connector.

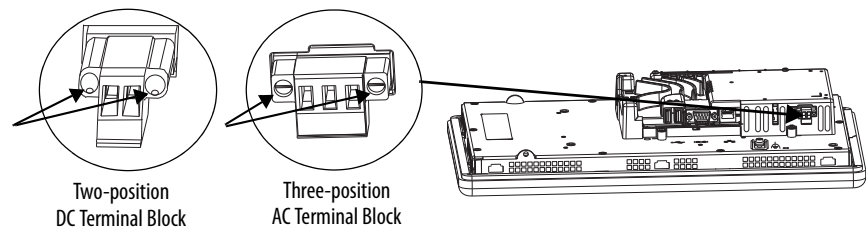

Follow these steps to install the terminal block.

1. Reattach the terminal block to the connector until seated.
2. Tighten the two screws that secure the terminal block to a torque of 0.40...0.51 N•m (3.5...4.5 lb•in).

DC Power Connections

Terminals with an integrated 24V DC power supply have these power ratings.

Table 17 - DC Power Ratings

| Terminal | Power Supply | Input Voltage, nom | Power Consumption, max |
|----------|--------------|----------------------|------------------------|
| 400, 600 | Nonisolated | 24V DC (18...30V DC) | 15 W (0.6 A at 24V DC) |
| 1000 | Isolated | 24V DC (18...32V DC) | 70 W (2.9 A at 24V DC) |

The power supply is internally protected against reverse polarity. Connecting DC+ or DC- to the earth/ground terminal can damage the device.



ATTENTION: Do not connect an AC power source to the terminal. Applying an AC power source to the terminal can damage the device.

External Power Supply

Use a dedicated 24V DC, safety extra-low voltage (SELV) or protective extra-low voltage (PELV) power supply to power each PanelView Plus 6 Compact device.



ATTENTION: Use a Class 2 SELV or PELV power supply as required by local wiring codes for your installation. These power supplies provide protection so that under normal and single fault conditions, the voltage between conductors and earth ground does not exceed a safe value.

PanelView Plus 6 Compact terminals were tested to operate with the catalog number 2711P-RSACDIN power supply. To use another power supply, review the criteria in [Table 18](#).

Table 18 - Power Supply Criteria

| If the PanelView Plus 6 Device | Use a | Description |
|--|--|--|
| Connects to equipment with isolated communication ports | SELV or PELV power supply | Other equipment can share this power supply with the PanelView Plus 6 device provided that no ground loops are created. A PELV source internally connects the negative power terminal to chassis ground. |
| Does not connect to other equipment | | |
| Connects to equipment with nonisolated communication ports | Dedicated, isolated, and ungrounded SELV source to power each terminal | This prevents ground loops from damaging the device. |

IMPORTANT All ports on the terminals are electrically isolated, except for the USB ports.

Earth/Ground Connection



PanelView Plus 6 compact terminals use a DC power input and have an earth/ground terminal that you must connect to a low-impedance earth/ground:

- On 400 and 600 terminals, the earth/ground connection is on the power terminal block.
- On 1000 terminals, the earth/ground connection is on the rear of the display module.

IMPORTANT The earth/ground connection to ground is mandatory. This connection is required for the following:

- Noise immunity, reliability, and Electromagnetic Compliance (EMC) with the European Union (EU) EMC directive for CE-mark conformance
- Safety by Underwriters Laboratory

Table 19 - Earth Wire Specifications for DC Power

| Terminal | Symbol | Wire Type | Wire Gauge | Terminal Screw Torque |
|----------|---|--|--|------------------------------------|
| 400, 600 |  GND | Stranded or solid Cu 90 °C (194 °F) | 2.1...3.3 mm ² (14...12 AWG) | 0.45...0.56 N·m (4...5 lb·in) |
| 1000 |  GND | Stranded or solid Cu 90 °C (194 °F) | 2.1...5.3 mm ² (14...10 AWG) | 1.13...1.36 N·m (10...12 lb·in) |



ATTENTION: Damage or malfunction can occur when a voltage potential exists between two separate ground points. Make sure the terminal does not serve as a conductive path between ground points at different potentials.

Connect DC Power



WARNING: Explosion Hazard

Do not disconnect equipment unless power has been switched off and area is known to be nonhazardous.

Disconnect all power before installing or replacing components. Failure to disconnect power can result in electrical shock or damage to the terminal.

Follow these steps to connect the terminal to DC power.

1. Verify that the terminal is not connected to a power source.
2. Strip 7 mm (0.28 in.) of insulation from the ends of the wires.

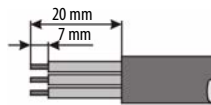

3. Secure the DC power wires to the marked terminals (+ and -) on the power terminal block.
4. Secure the earth/ground wire:
 - On 400 and 600 terminals, secure the earth/ground wire to the functional earth/ground terminal on the power terminal block.
 - On 1000 terminals, secure the earth/ground wire to the functional earth screw on the back of the display.

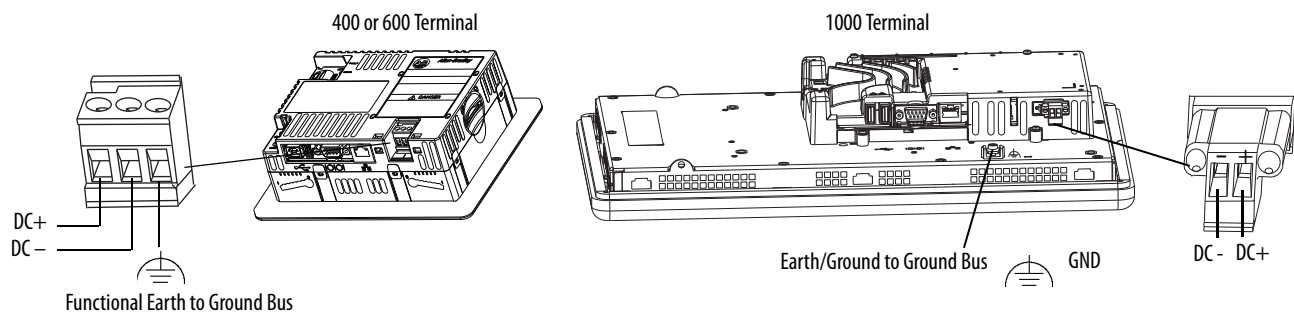

5. Apply power to the terminal.

Initial Startup

The first time you start the system, the terminal goes through its power-up sequence and launches FactoryTalk View ME Station Configuration mode.

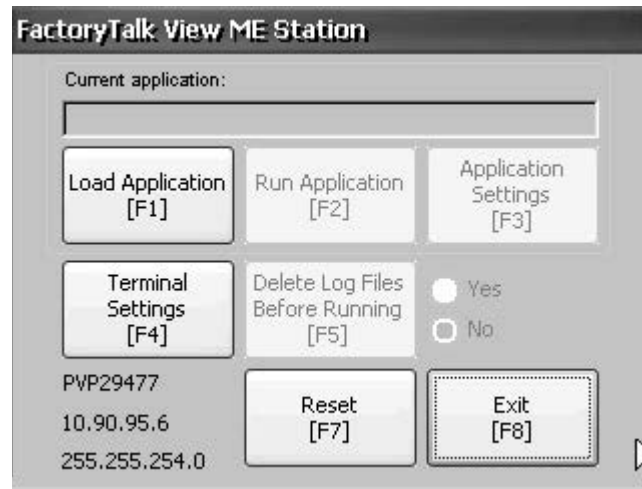

You can change the action the terminal takes on startup by pressing Terminal Settings then choosing Startup Options. You can configure one of these options:

- Launch a FactoryTalk Machine Edition HMI application that is configured to run at startup.
- Launch FactoryTalk View ME Station Configuration mode and run the configuration options for the terminal (default).
- Launch the Windows Explorer desktop.

You can also configure a terminal to allow desktop access. Terminals are initially shipped with desktop access disabled. To allow or restrict desktop access, press Terminal Setting, then choose Desktop Access.

For more information on changing the start-up option and restricting or allowing desktop access, refer to [Chapter 3 - Configuration Mode](#).

Reset Terminal

You have several options to restart the terminal without having to disconnect and reapply power:

- Use the Reset switch on the back of the terminal.
- From the terminal desktop Start menu, choose Programs>Restart System.
- On the FactoryTalk View ME Station configuration dialog box, press Reset.

After a restart, the terminal performs a series of start-up tests then takes one of these actions:

- Launches an HMI application that is configured to run at startup.
- Launches FactoryTalk ME Station Configuration mode.
- Launches the Windows Explorer desktop.

The action that occurs depends on the start-up options configured for the terminal. Refer to [Start-up Options on page 39](#) for details.

Refer to [Start-up Messages and Codes on page 145](#) for a list of start-up information and error messages.

Follow these steps to restart the system by using the RESET switch.

1. Insert a thin, nonconductive object into the RESET area.



ATTENTION: Use a nonconductive object to press the RESET switch. Do not use a conducting object such as a paper clip or the tip of a pencil. Either can damage the terminal.

2. Press and release the RESET switch.

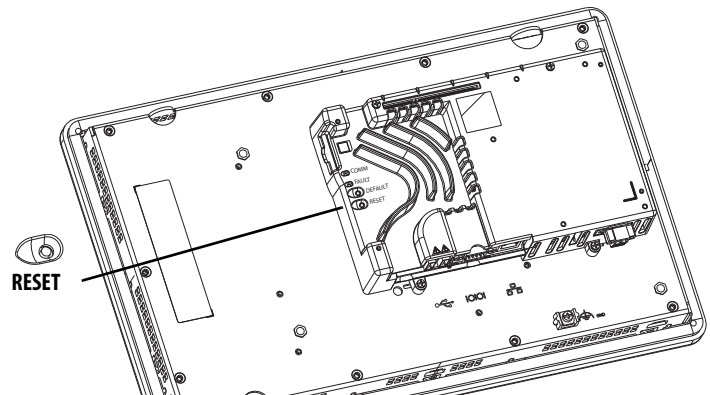
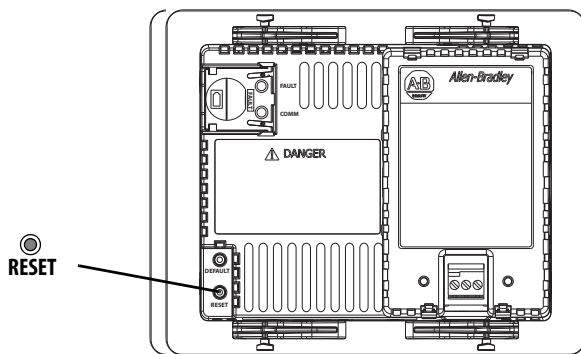

Follow these steps to restart the system from the Windows desktop.

1. From the Start menu, choose Programs>Restart System.
You are asked to confirm the restart.
2. Click Yes to restart or No to cancel.

Follow these steps to restart the system from FactoryTalk View ME Station software.

1. Access Configuration Mode.

Refer to [Access Configuration Mode on page 33](#) for ways to launch FactoryTalk View ME Station Configuration mode.

2. Press Reset [F7].

Configuration Mode

| Topic | Page |
|------------------------------|------|
| Access Configuration Mode | 33 |
| Terminal Settings | 36 |
| Load and Run Application | 38 |
| Start-up Options | 39 |
| Desktop Access | 42 |
| Communication Setup | 46 |
| Ethernet Network Connections | 48 |
| File Management | 52 |
| Display Settings | 55 |
| Input Device Settings | 57 |

| Topic | Page |
|--------------------------------------|------|
| Configure Print Options | 60 |
| Check Integrity of Application Files | 62 |
| Configure Diagnostics | 63 |
| View and Clear the System Event Log | 64 |
| System Information | 64 |
| Enable or Disable the Alarm Display | 66 |
| Time and Date Settings | 67 |
| Regional Settings | 69 |
| Font Linking | 72 |

Access Configuration Mode

The terminal uses built-in software, FactoryTalk View ME Station, to configure start-up options, load and run applications, access the Windows desktop, and perform other terminal operations. When you reset the terminal, one of these actions occurs, depending on the configured start-up option:

- FactoryTalk View ME Station Configuration mode is launched (closed system). This is the initial default.
- FactoryTalk View Machine Edition .mer application is set to run (closed system).
- Windows Explorer desktop is launched (open system).



From the Windows Explorer desktop, double-click the FactoryTalk View ME Station icon to access the Configuration mode of the terminal.

-
- IMPORTANT**
- To access Configuration mode from a running application, press Goto Configuration Mode. This button is added to application screens in FactoryTalk View Studio software during application development. The application stops running but is still loaded.
 - Refer to [Configuration Mode Access on page 149](#) for details on how to access Configuration mode if the application does not contain a Goto Configuration Mode button.
-

Figure 5 - FactoryTalk View ME Station Configuration Mode

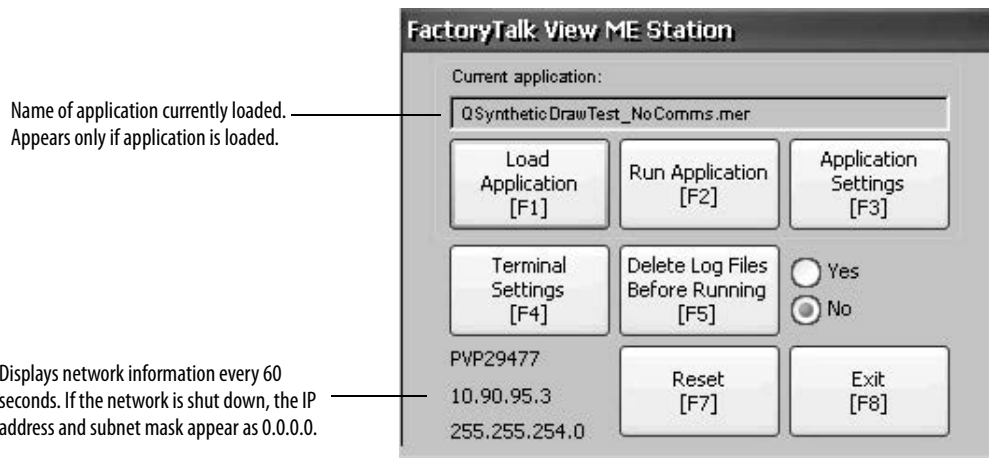

Table 20 - Configuration Mode Operations

| Terminal Operation | Description |
|--------------------------------------|---|
| Load Application [F1] | Opens a dialog box where you select an application to load. The loaded application name appears under Current application. |
| Run Application [F2] | Runs the loaded .mer application displayed under Current application. You must load an application before running it. |
| Application Settings [F3] | Opens a menu of application-specific configuration settings, such as device shortcuts defined for the loaded .mer application. Device shortcuts are read-only and cannot be edited. For example, your .MER application can have CLX defined as a device shortcut name for a ControlLogix® controller. |
| Terminal Settings [F4] | Opens a menu of options to configure non-application, terminal settings for the PanelView Plus 6 device. |
| Delete Log Files Before Running [F5] | Toggles between Yes and No. If you select Yes, all data log files, alarm history, and alarm status file are deleted before the application is run. If you select No, log files are not deleted first. Deleting log files is a way to reclaim memory in the terminal. |
| Reset [F7] | Resets the terminal, then launches the HMI application, configuration mode, or the desktop depending on the configured start-up option. |
| Exit [F8] | Exits Configuration mode. If desktop access is allowed, you can access the desktop. |

Navigation Buttons

Many FactoryTalk View ME Station dialog boxes have data entry and navigation buttons:

- On touch-screen terminals, press the button with your finger or stylus.
- On keypad terminals, press the function key listed on the button.
- If a mouse is attached, click a button.

Table 21 - Navigation Buttons

| Button | Description | Button | Description |
|------------------------|---|--------|---|
| Close [F8] | Returns to the previous dialog box. Press this button from the Configuration mode dialog box to access the desktop, if allowed. | ▲ ▼ | Moves highlight up or down a list. |
| OK [F7] Cancel [F8] | Accepts changes and returns to previous dialog box or cancels the operation without saving changes. | ↩ | Selects a highlighted function or item from a list. |

Device Name

When you activate a data entry field, the Device Name input panel opens. If the field is restricted to a numeric value or IP address, then only the 0...9 and decimal point keys are enabled.

Figure 6 - Device Name Input Panel

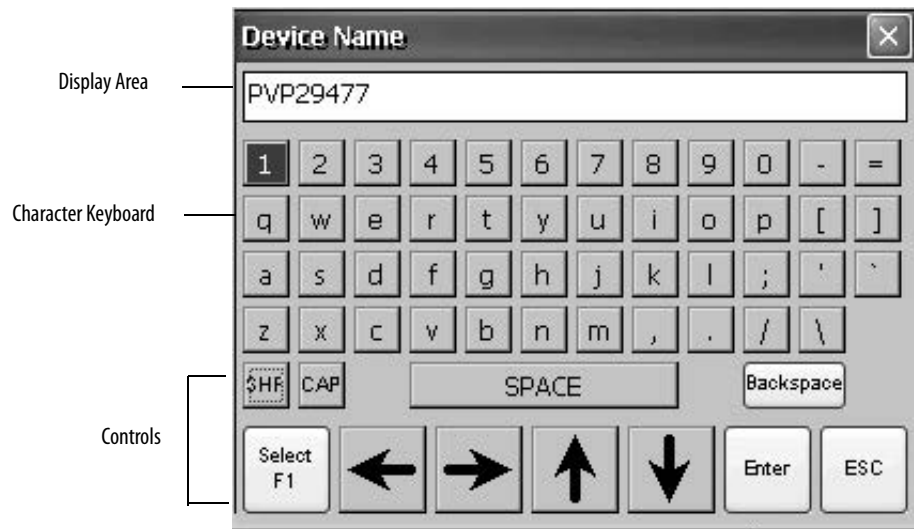

Figure 7 - Device Name Input Panel Controls

| Device Name Input Panel Controls | Function |
|----------------------------------|---|
| SHF | Switches keys between their shifted and unshifted state. The initial default is unshifted. |
| CAP | Switches keys between lowercase and uppercase characters. The initial default is lowercase. |
| SPACE | Enters a space between characters in the display area. |
| Backspace | Deletes the previous character (to the left of the cursor) in the display area. |
| Select F1 | Selects a character and enters it in the display area. |
| Left, Right, Up, Down Arrow Keys | Selects the character to the left, right, above, or below the currently selected character. |
| Enter | Accepts the entered characters and returns to the previous dialog box. |
| ESC | Cancels the current operation and returns to the previous dialog box. |

Follow these steps to enter characters in the display area.

1. Press a character on the keyboard:
 - On a touch-screen terminal, press a key.
 - On a keypad terminal, press the arrow keys on the keypad to navigate to a key.
 - If a mouse is attached, click a key.
2. Press Select to copy the character to the display area.
3. Press Enter when done to exit the input panel.

Terminal Settings

You can modify settings on the terminal that are not specific to the application.

1. From the FactoryTalk View ME Station Configuration Mode dialog box, press Terminal Settings.

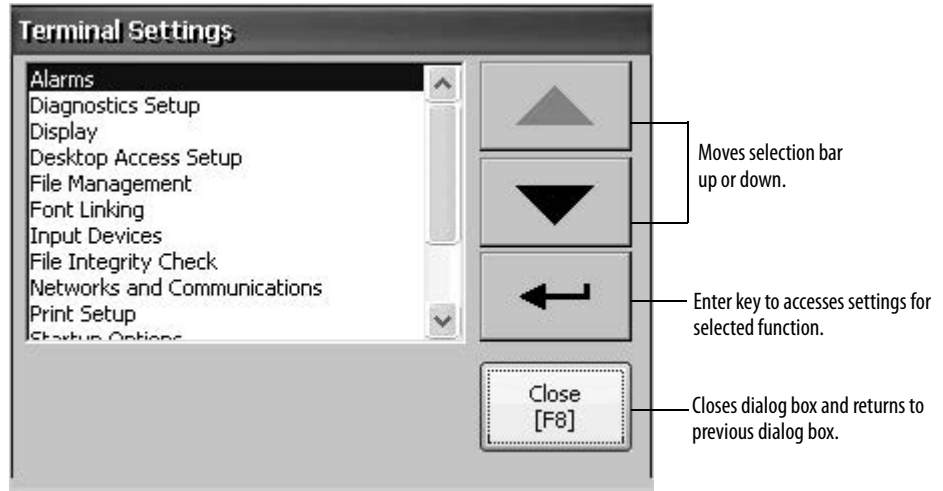

2. Use the up and down cursor buttons to select a function:
 - On touch-screen terminals, press the button.
 - On keypad terminals, press the key on the keypad or the corresponding terminal function key.
3. Press the Enter key to access selected function.

Table 22 - Terminal Settings

| Terminal Settings | Description |
|-----------------------------|--|
| Alarms | Specifies whether to close the alarm display on the terminal when the newest alarm is acknowledged by an operator. By default, the alarm display is closed. |
| Diagnostics Setup | Forwards diagnostic messages from a remote log destination to a computer running diagnostics. |
| Display | Sets the intensity of the backlight, configures the screen saver, and enables the touch-screen cursor. |
| Desktop Access Setup | Specifies whether the desktop can be accessed with or without a password, and lets you set/reset the password. |
| File Management | Copies application files and font files to the terminal, an SD card, or a USB drive. You can also delete application files from the terminal, an SD card, or USB drive. Log files generated by the application can be deleted from the terminal. |
| Font Linking | Links a font file to a base font loaded on the terminal. |
| Input Devices | Configures settings for the keypad, touch screen, or attached keyboard and mouse, including touch-screen calibration. Also lets you choose between a pop-up character input or pop-up keyboard for string input. |
| File Integrity Check | Checks the integrity of the .mer application file and runtime files by logging details to a file integrity check log. You can view and clear this log at any time. |
| Networks and Communications | Configures Ethernet or other communication settings for applications. |
| Print Setup | Configures settings for printing displays, alarm messages, and diagnostics messages generated by the application. |
| Startup Options | Specifies whether the terminal launches the desktop, Configuration mode, or runs an application on startup. |
| System Event Log | Displays system events logged by the terminal and lets you clear events from the log. |
| System Information | Displays power, temperature, battery, and memory details for the terminal. Also shows the firmware number for FactoryTalk View ME software and technical support information. |
| Time/Date/Regional Settings | Sets the date, time, language, and numeric format used by the terminal and applications. |

Figure 8 - Terminal Settings Menu Structure

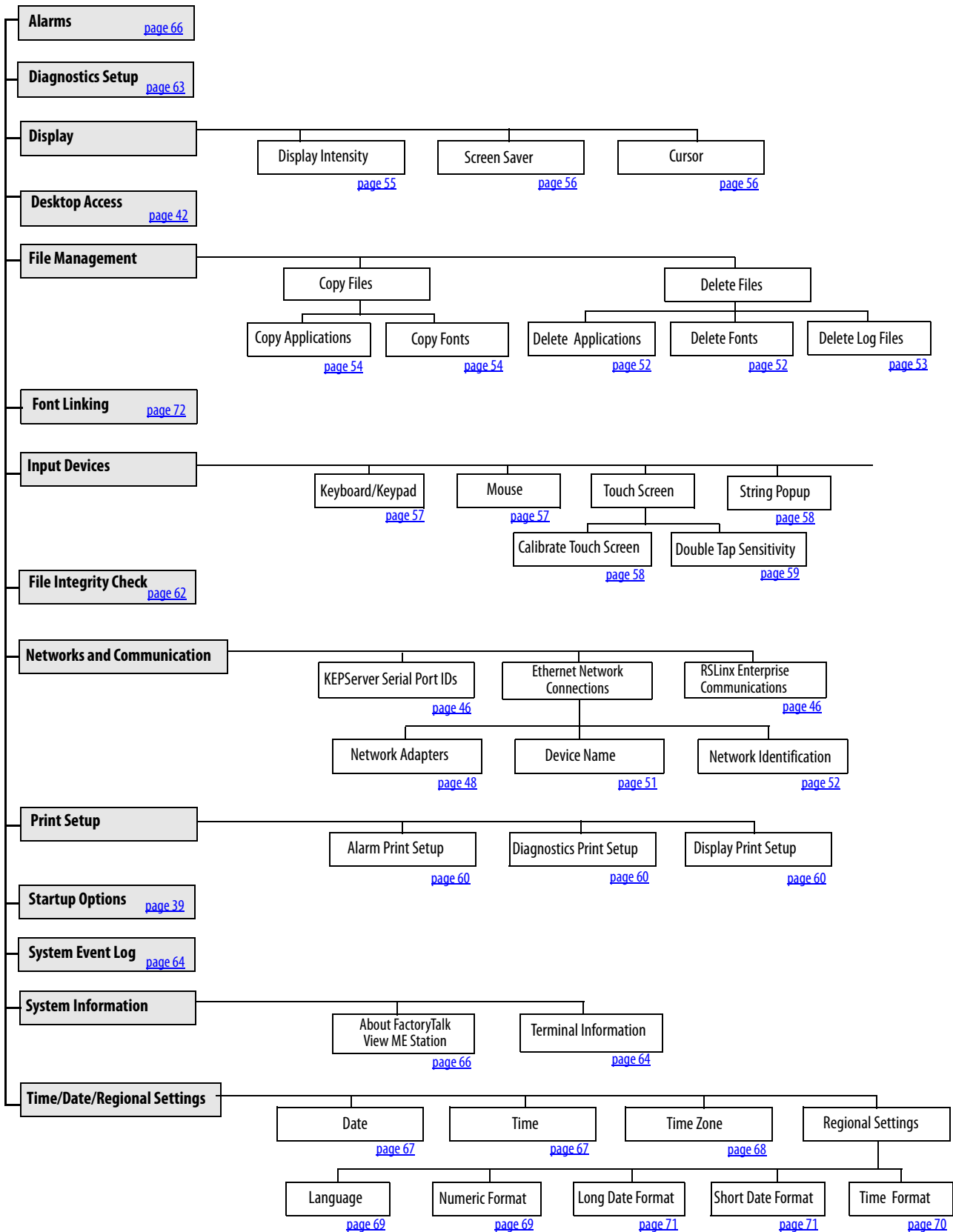

Load and Run Application

Before running a FactoryTalk View Machine Edition .mer application, you must first load the application. You can load a .mer application from internal storage or nonvolatile memory in the terminal, an SD card, or a USB drive.

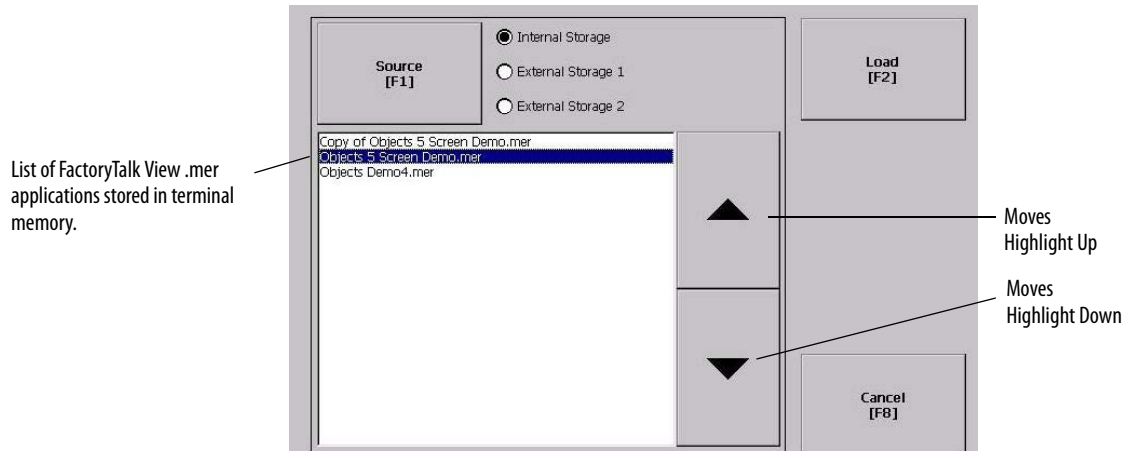

Follow these steps to load and run an application.

1. Press Load Application from the Configuration mode dialog box.
2. Press Source to select the location of the file you want to load:
 - Internal Storage – nonvolatile memory of the terminal.
 - External Storage 1 – SD card loaded in the card slot of the terminal.
 - External Storage 2 – USB drive connected to a USB host port.

TIP The recognized path for Machine Edition files on the terminal, USB drive, or SD card is \Application Data\Rockwell Software\RSViewME\Runtime\. On the terminal, the path is in My Device on the desktop.

3. Use the up and down cursor keys to select a .mer file from the list.
4. Press Load to load the selected application.

You are asked if you want to replace the terminal's communication configuration with the configuration in the application.

5. Select Yes or No.

If you select Yes, any changes to the device addresses or driver properties in the RSLinx Communications dialog box are lost.

The name of the currently loaded application appears at the top of the main Configuration mode dialog box.

6. Press Run on the Configuration mode dialog box to run the loaded application.

TIP Applications generate log files. To delete log files before running an application, press Delete Log Files Before Running on the Configuration Mode dialog box. Deleting log files reclaims terminal memory.

TIP [Refer to Start-up Options on page 39](#) to set the application to automatically run on startup or a terminal reset.

Start-up Options

You can specify what action the terminal takes on startup or a reset.

| This Start-up Option | Performs This Action | Typical System |
|--|--|----------------|
| Do not start FactoryTalk View ME Station | Launches the Windows Explorer desktop on startup. | Open |
| Go to Configuration Mode | Launches FactoryTalk View ME Station Configuration mode on startup. This is the factory default setting. | Closed |
| Run Current Application | Runs the FactoryTalk View ME application loaded in the terminal on startup. | Closed |

IMPORTANT When desktop access is restricted, the start-up option must be set to Run Current Application or Go to Configuration Mode (default). Refer to [page 42](#) for details on how to enable or disable desktop access.

Disable FactoryTalk View ME Station Software on Startup

Terminals with extended features and file viewers are typically configured to launch the Windows desktop on startup. This means you must disable FactoryTalk View ME Station from launching on startup.

TIP The desktop can also be launched from FactoryTalk View ME Station Configuration mode by pressing Exit.

Follow these steps to disable FactoryTalk View ME Station on startup so that the desktop can launch.

1. Press Terminal Settings>Startup Options.

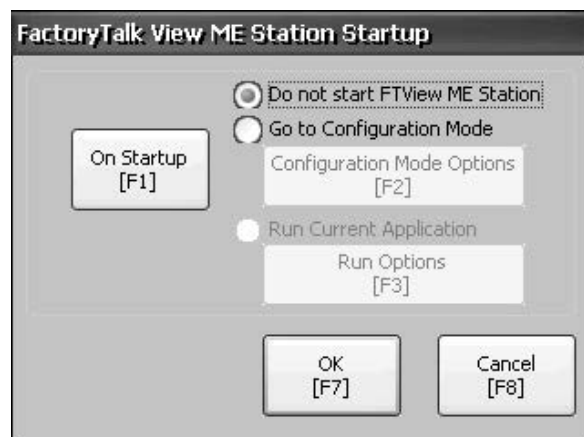

2. Press On Startup until 'Do not start FactoryTalk View ME Station' is selected.

TIP When disabling FactoryTalk View ME Station, desktop access must be set to allow or you get a warning. Refer to [Enable Desktop Access on page 42](#).

3. Press OK.

Enter Configuration Mode on Startup

Follow these steps to automatically launch the FactoryTalk View ME Station Configuration mode dialog box on startup.

1. Press Terminal Settings>Startup Options.
2. Press On Startup to select Go to Configuration Mode.

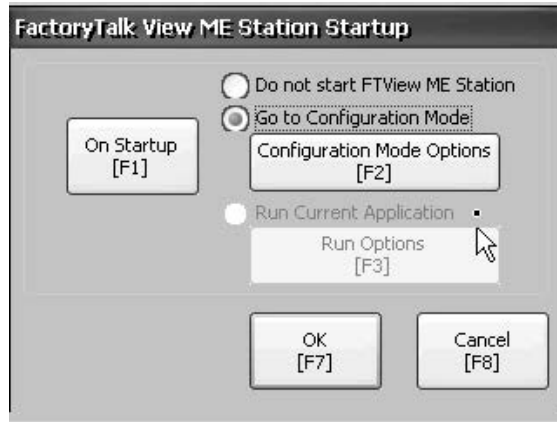

3. Press Configuration Mode Options.

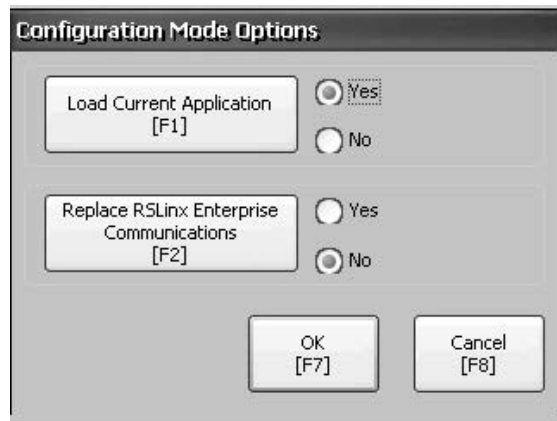

4. Press Load Current Application to specify whether you want to load the current application on startup.
5. Press Replace RSLinx Enterprise Communications to specify whether to use the communication configuration of the current application or that of the terminal on startup:
 - Select No to use the RSLinx configuration of the terminal.
 - Select Yes to use the configuration of the application. The terminal configuration is replaced with the application settings. Any changes to device addresses or driver properties in RSLinx communication are lost.
6. Press OK to return to the previous dialog box.
7. Press OK to return to Terminal Settings.

Run the Loaded Application on Startup

Follow these steps to run the FactoryTalk View .mer application currently loaded in the terminal on startup. This is typical when running a closed system.

1. Press Terminal Settings>Startup Options.

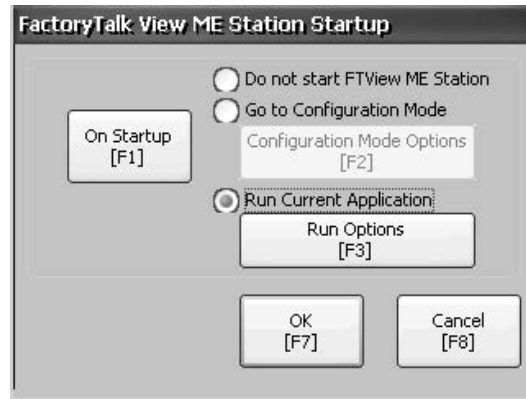

2. Press On Startup to select Run Current Application.

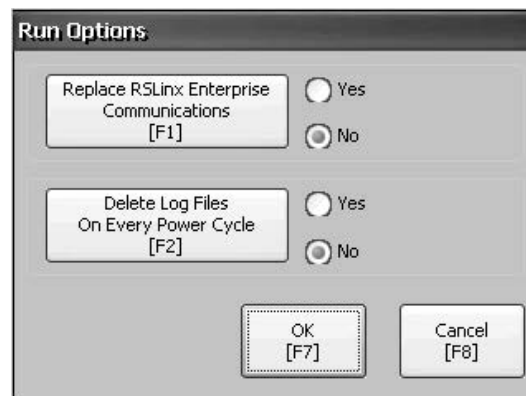

If an application is not loaded, the options are disabled.

3. Press Replace RSLinx Enterprise Communications to specify what configuration settings to use when running the application:
 - Select No to use the RSLinx configuration of the terminal.
 - Select Yes to use the configuration of the application. The terminal configuration is replaced with the application settings. Any changes to device addresses or driver properties in RSLinx communication are lost.
4. Press Delete Log Files On Every Power Cycle to specify what action to take with the log files on startup:
 - Select Yes to delete all log files (data, alarm history, alarm status) generated by the terminal before running application. The files are deleted from the system default location.
 - Select No to retain all log files.
5. Press OK twice to return to Terminal Settings.

Desktop Access

You can allow or restrict access to the Windows desktop on the terminals. From the desktop, you can perform system and control panel operations, or run third-party applications. Terminals with extended features can additionally run viewers, media players, and launch the web browser. You can also allow temporary access to perform specific tasks, then disable desktop access to prevent unauthorized changes.

Typically, a terminal does not allow desktop access unless it has extended features.

TIP All terminals are shipped from the factory with desktop access disabled.

With restricted access, the only way to access the desktop is to first enter a password. The terminals are shipped from the factory with this default password and challenge question that we recommend you change:

- Default password = password (case sensitive)
- Default challenge question = What is the opposite of lock?
- Default challenge answer = unlock (case sensitive)

When desktop access is set to allow, you can access the desktop by pressing Exit from FactoryTalk View ME Station Configuration mode.

Enable Desktop Access

Follow these steps to enable desktop access.

1. Press Terminal Settings>Desktop Access Setup.
2. Press Desktop Access to select Allow.

The Enter Password dialog box opens.

TIP Each time you change access from disallow to allow, you are required to enter a password. The initial default password is 'password'.

3. Press Password to enter the password and press Enter.
4. Press Enter again to return to Desktop Access Management.

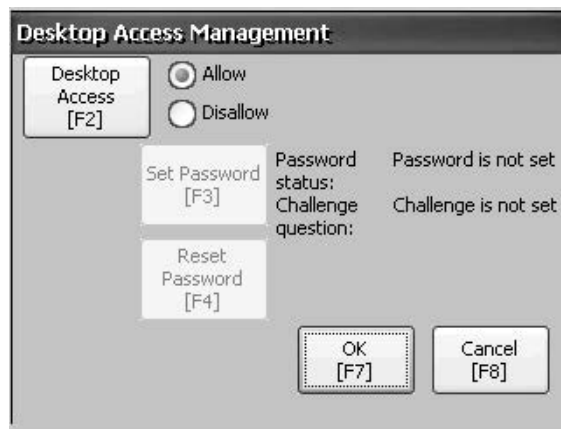

Notice that the password has been cleared.

5. Press OK to exit Desktop Access Management, then Close to exit Terminal Settings.
6. Press Exit from FactoryTalk View ME Station Configuration mode to access the desktop.

With desktop access set to allow, you are not required to enter a password.

Disable Desktop Access

To restrict desktop access, the FactoryTalk View ME Station start-up option must be set to one of these options:

- Go to Configuration Mode (this is the default)
- Run Current Application

See [page 39](#) for details on how to change the start-up option.

You also are required to enter a password and challenge question:

- The password is required to access the desktop from FactoryTalk View ME Station Configuration mode when pressing Exit.
- The challenge question and response are required to change the password with the Reset Password function.

Follow these steps to disable desktop access.

1. Press Terminal Settings>Desktop Access Setup.
2. Press Desktop Access to select Disallow.

The Set Password button is enabled.

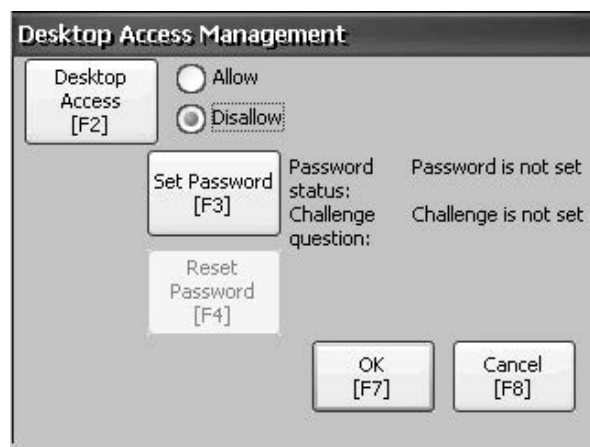

TIP If the start-up option was not set to Run Current Application or Go to Configuration mode, you get an error.

3. Refer to [Set a Desktop Password on page 44](#) to set a password and challenge question.

You must set a password and challenge question when disabling desktop access or you get an error message.

Set a Desktop Password

IMPORTANT If you disallow or restrict access to the desktop, you are required to set a password along with a challenge question.

Follow these steps to set a new password.

1. Press Set Password from Desktop Access Management.

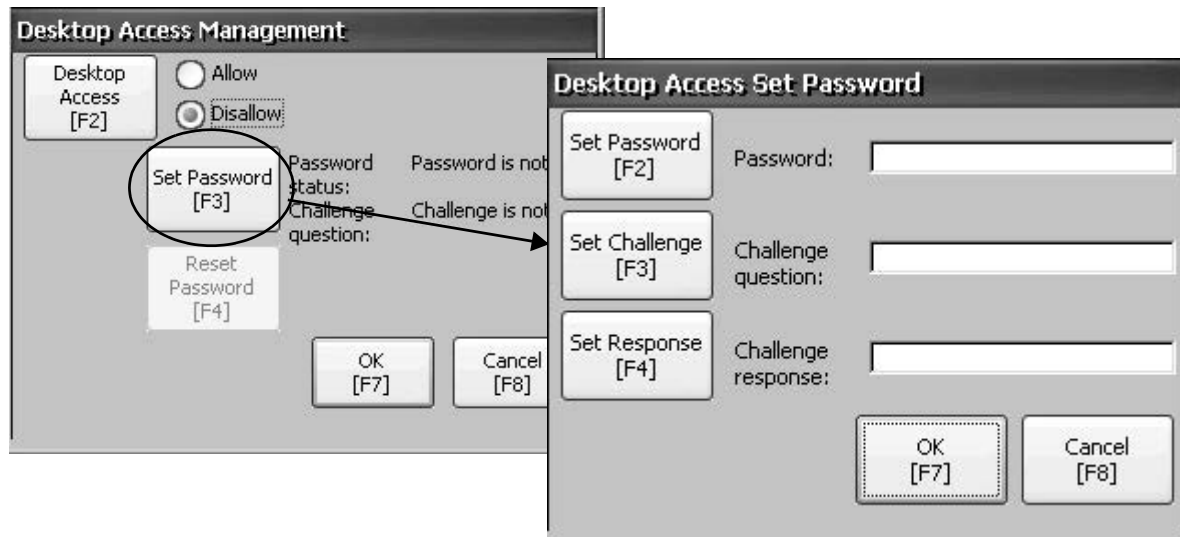

2. Press Set Password and enter an 8- to 20-character password, then press Enter.

TIP You must correctly enter this password before accessing the desktop.

3. Press Set Challenge and enter a question that you must correctly respond to before changing the password with the Reset Password button.
4. Press Set Response to enter the response to the challenge question, then press Enter.
5. Press OK.

The Desktop Access Management dialog box shows that a password and challenge question are set.

6. Press OK to return to Terminal Settings.

IMPORTANT Secure your password and challenge question for future use. To clear and reset the password, you must correctly respond to the challenge question. If you forget the response, the only way to clear the password is to restore the factory default settings on the terminal. Refer to [Maintenance Operations on page 151](#) for details on how to restore factory defaults.

Reset the Desktop Password

To clear the current password and reset a new password, you must first correctly respond to the current challenge question. If you cannot remember the response, you have to restore the terminal to its factory default settings. Refer to [Maintenance Operations on page 151](#) for details.

IMPORTANT You can clear and reset the password and challenge question if access to the desktop is restricted or set to disallow.

Follow these steps to reset a desktop access password.

1. From Desktop Access Management, press Reset Password.

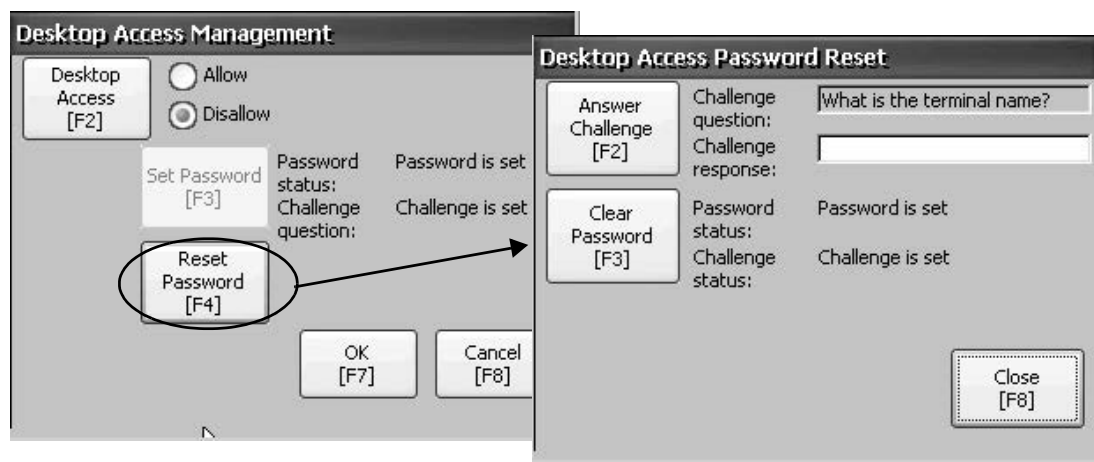

2. Press Answer Challenge and enter the correct response to the current challenge question.
3. Press Clear Password to clear the current password and challenge question.
The status of the password and challenge information is updated.

Password status: Password is not set
Challenge status: Challenge is not set

4. Press Close.
5. Follow the [Set a Desktop Password](#) procedure on [page 44](#) to set a new password and challenge question.

After the password is cleared, you must set a new desktop password or change the desktop access to allow.

Communication Setup

Use RSLinx Enterprise software to configure these communication settings for your application and controller:

- Access KEPServer Serial Port IDs.
- Edit the driver settings for the protocol used by your .mer application.
- Edit the device address of the controller on the network.

Configure KEPServer Serial Port IDs

To access KEPServer serial communication, you must have KEPServer Enterprise installed on your terminal.

To access the KEPServer Serial Port ID dialog box, press Terminal Settings>Networks then Communications>KEPServer Serial Port IDs. If KEPServer Enterprise is not installed, you get an error message.

Configure RSLinx Communication Properties

Follow these steps to configure driver settings for the communication protocol used by your application.

1. Press Terminal Settings>Networks then Communications>RSLinx Enterprise Communications.

You see a tree view of installed cards and network configurations.

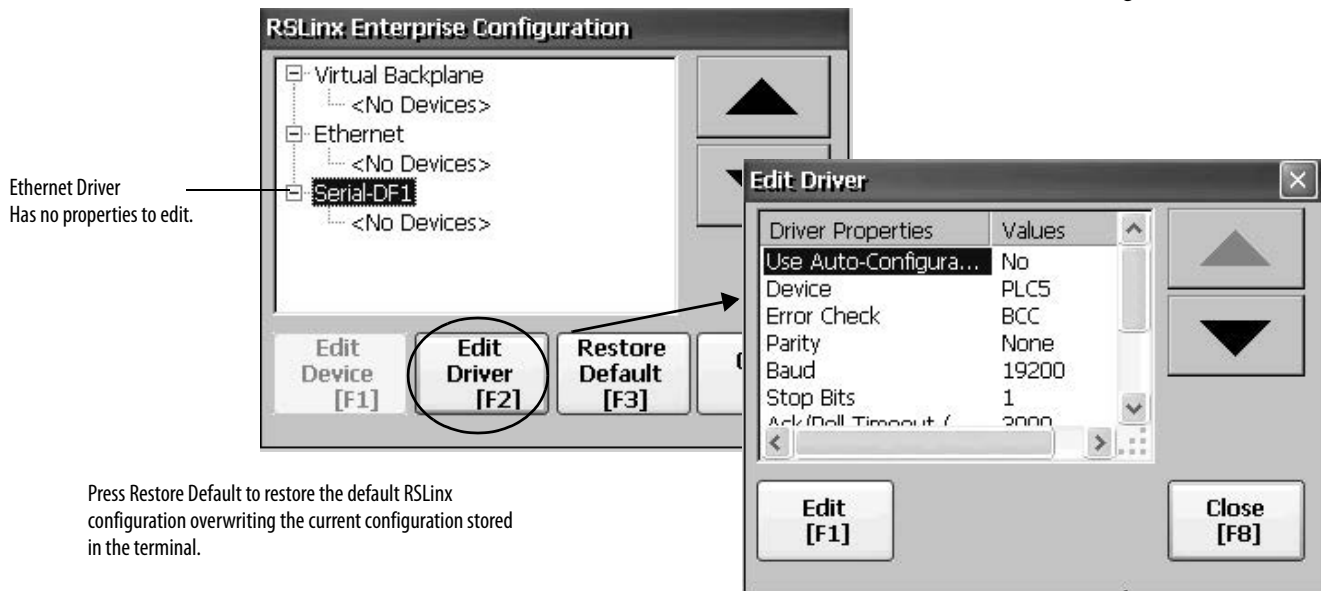

2. Select a communication card installed on your terminal.
3. Press Edit Driver to view the current driver properties.
4. Select a property to modify, then press Edit.
5. Modify the setting, then press Enter.

You return to the previous dialog box with the newly entered data.

Table 23 - Communication Driver Properties

| Field | Description | Valid Values |
|--------------------------|--|--|
| Serial Properties | | |
| Use Auto Config | Automatically or manually configures the baud rate, parity, and error checking parameters. | Yes (auto configure) No (manual configure) |
| Device | The serial device that the terminal is connected to. | PLC-5 [®] , SLC [™] , MicroLogix [™] , Logix Platform |
| Error Check | Type of error checking used. Error checking is automatically configured if Use Auto Config is set to Yes. | BCC, CRC |
| Parity | Type of parity used. Parity is automatically configured if Use Auto Config is set to Yes. | None, Odd, Even |
| Baud Rate | Data rate at which serial driver communicates. The baud rate is automatically configured if Use Auto Config is set to Yes. | 110, 300, 600, 1200, 4800, 9600, 19200, 38400, 57600, 115200 |
| Stop Bits | Number of stop bits used. | 1 or 2 |
| Ack/Poll Timeout | Ack/Poll timeout value in ms. | 20...60,000 ms |
| Max Retries | Number of retries before serial driver fails. | 0...10 |
| Station Number | Station number based on a specific device. | 0...254 |
| COM Port | Communication port used on the terminal. | 1...4 |
| DH-485 Properties | | |
| Jumper ID | Identifies the communication card if multiple cards are installed on the terminal. | 0...3 |
| Station Number | The unique station number of the terminal on the DH-485 network. | 0...31 (decimal) |
| Baud Rate | The communication rate of the DH-485 network. | 9600 19200 |
| MaxStationNumber | The maximum station number on the DH-485 network. The value must be greater than or equal to the Station Number. | 0...31 (decimal) |

Configure a Device Address

Follow these steps to edit the address of a device such as a logic controller.

1. From the RSLinx Configuration dialog box, select a device node.
2. Press Edit Device to view the device name and current address.

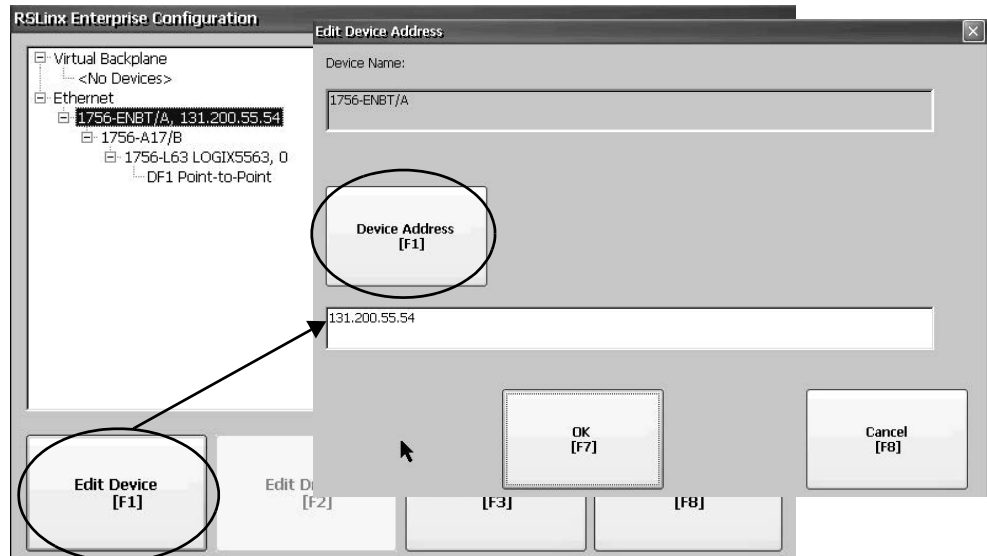

3. Press Device Address to modify the address.

The input panel opens with the current address.

4. Use the input panel to modify the address then press Enter.
You return to the previous dialog box with the new address.
5. Press OK.

IMPORTANT Modified settings do not take effect until the terminal is restarted.

Ethernet Network Connections

The terminal has a built-in Ethernet driver. You can configure this Ethernet information for your terminal:

- IP address of the terminal on the network including link speed
- Device name to identify the terminal on the network
- Username and password to access network resources

Set the Ethernet IP Address for the Terminal

Some networks automatically assign IP addresses to Ethernet devices if DHCP is enabled. If DHCP is not enabled, you can manually enter an IP address.

Follow these steps to view or enter the IP address of your terminal.

1. Press Terminal Settings>Networks then Communications>Network Connections>Network Adapters.

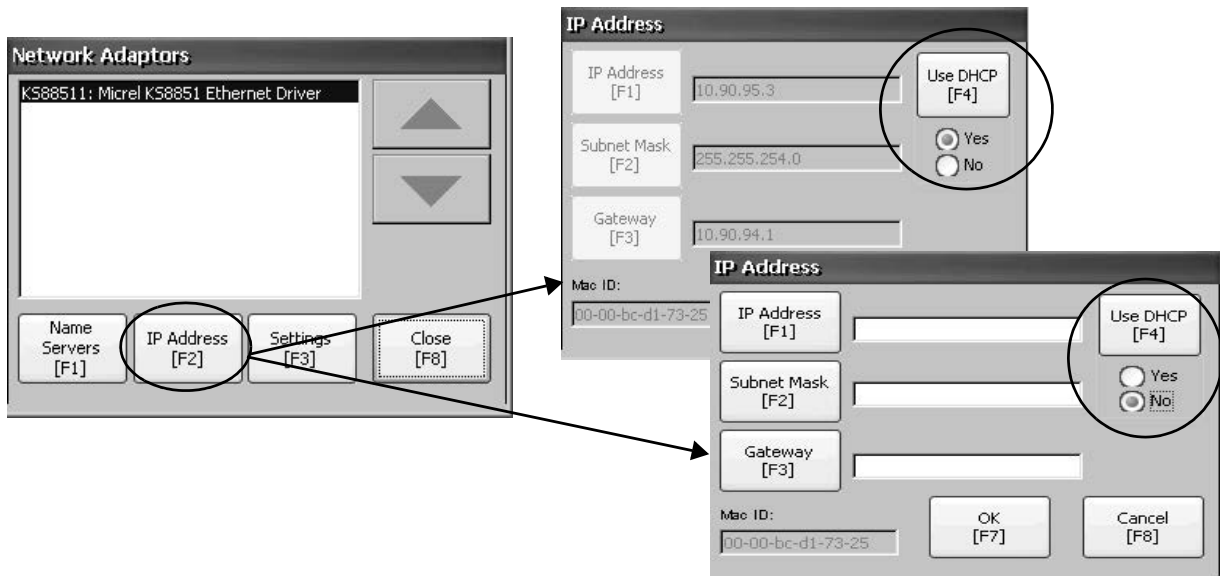

2. Press IP Address to view or modify the IP address.
3. Press Use DHCP to enable or disable DHCP assignment of addresses.
 - If DHCP is enabled or set to Yes, IP address are automatically assigned.
 - If DHCP is disabled, you can manually enter the IP address. Press IP address, Subnet Mask, and Gateway to enter IP formatted addresses.
4. Press OK when done.

If prompted, reset the device from the FactoryTalk View ME Station Configuration mode dialog box.

5. Press Close.

| Field | Description | Valid Values |
|-------------|---|--|
| Use DHCP | Enables or disables Dynamic Host Configuration Protocol (DHCP) settings. DHCP automatically allocates network devices and configurations to newly attached devices on the network: <ul style="list-style-type: none"> • If DHCP is set to Yes, the terminal is automatically assigned an IP address, Subnet Mask, and Gateway. The fields are disabled. • If DHCP is set to No, you can enter the IP address, Subnet Mask, and Gateway address. | Yes (default) No |
| IP Address | A unique address identifying the terminal on the Ethernet network. | xxx.xxx.xxx.xxx 000.000.000.000 (default) <ul style="list-style-type: none"> • Range of values for the first set of decimal numbers is 1...255 unless all fields are set to 000. • The range of values for the last three sets of decimal numbers is 0...255. |
| Subnet Mask | Address must be identical to the server subnet mask. | xxx.xxx.xxx.xxx |
| Gateway | Optional Gateway address. | xxx.xxx.xxx.xxx |
| Mac ID | Read-only field. | — |

Set the Ethernet Link Speed

You can set the speed and duplex setting of the Ethernet link.

1. Press Terminal Settings>Networks then Communications>Network Connections>Network Adapters.

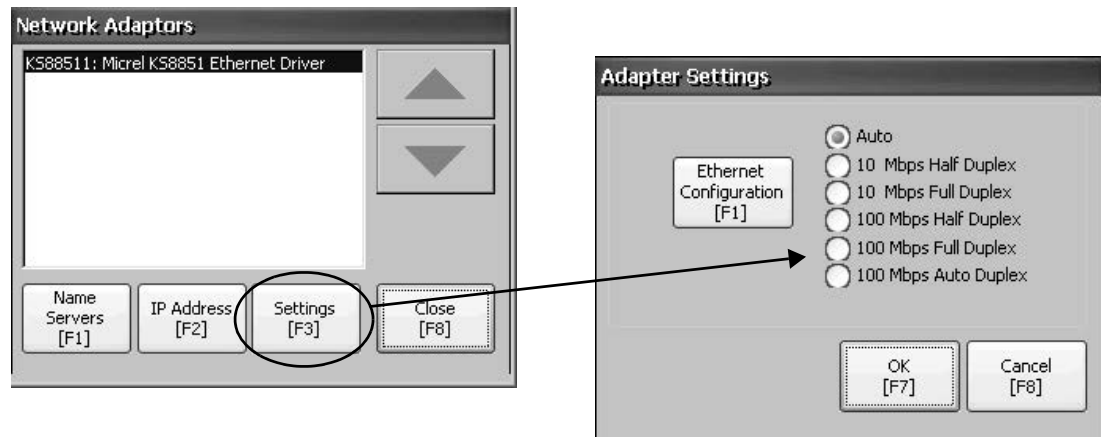

2. Press Settings to view or modify the Ethernet link settings.
3. Press Ethernet Configuration to select an Ethernet link option for your Ethernet connection.

The Auto option automatically senses the link option and speed based on the terminal connection to a network.

Define Name Server Addresses

You can define name server addresses for the EtherNet/IP network adapter. These addresses are automatically assigned if DHCP is enabled for the adapter.

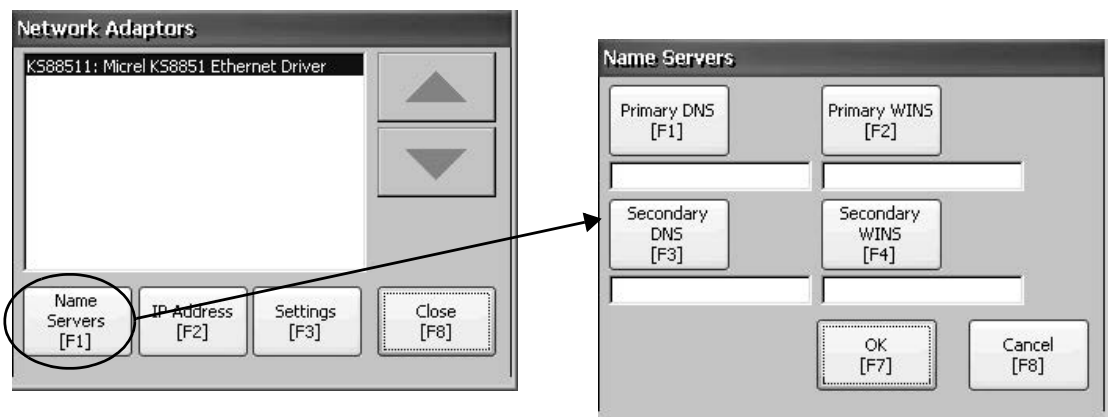

Follow these steps to define a name server address.

1. Press Terminal Settings>Networks then Communications>Network Connections>Network Adapters.
2. Press Name Servers.
3. Press the following fields to enter name server addresses.

| Field | Description | Valid Values |
|----------------|---|-----------------|
| Primary DNS | The address of the primary DNS resolver. | xxx.xxx.xxx.xxx |
| Secondary DNS | The address of the secondary DNS resolver. | xxx.xxx.xxx.xxx |
| Primary WINS | The address of the primary WINS resolver. | xxx.xxx.xxx.xxx |
| Secondary WINS | The address of the secondary WINS resolver. | xxx.xxx.xxx.xxx |

4. Press OK when done.

View or Change Terminal Device Name

Each terminal has a default device name and description that is used to identify the terminal on the network. You can view or modify this information.

1. Press Terminal Settings>Networks then Communications>Network Connections>Device Name.

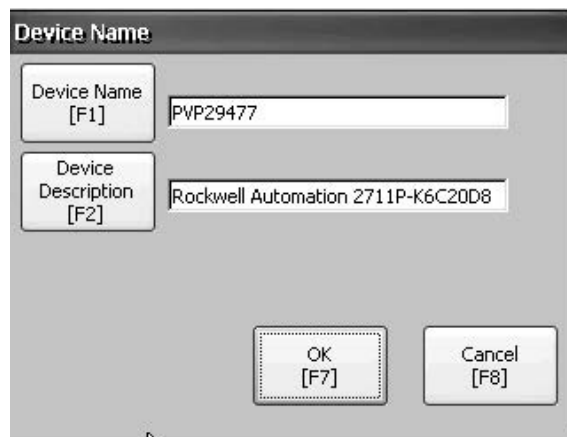

2. Press Device Name to enter or edit the device name.
3. Press Device Description to enter a description for the device.

| Field | Description | Valid Values |
|----------------------------|---|---|
| Device Name ⁽¹⁾ | Unique name that identifies the terminal to other computers on the network. | 1...15 characters <ul style="list-style-type: none"> • A leading character in the range of a through z or A through Z. • Remaining characters in the range of a through z, A through Z, 0...9, or - (hyphen) |
| Device Description | Provides a description of the terminal. The default is the logic module catalog number. | 50 characters max |

(1) Check with your network administrator to determine a valid device name.

4. Press OK.

Authorize Terminal to Access Network Resources

The terminal can access network resources with proper identification. A user name, password, and domain must be provided by your network administrator.

1. Press Terminal Settings>Network then Communications>Network Connections>Network Identification.

The screenshot shows a dialog box titled "Network Identification". It has three input fields: "User Name [F1]", "Password [F2]", and "Domain [F3]". The password field is masked with asterisks. At the bottom of the dialog are two buttons: "OK [F7]" and "Cancel [F8]".

2. Press user name, password, and domain to enter the information provided by your network administrator.

| Field | Description | Valid Values |
|-------------|--|-------------------------|
| User Name | Identifies the user to the network. | 70 characters max |
| Password | Characters that gain access to network along with the user name. | No character limitation |
| Domain Name | Provided by network administrator. | 15 characters max |

3. Press OK when done.

File Management

The terminal supports operations for managing files that are stored on the terminal:

- Deleting application .mer files, font files, or generated log files
- Copying application files or font files between storage locations

Delete Application File or Font File

You can delete FactoryTalk View ME Station .mer files or font files that reside in the nonvolatile memory of the terminal, a loaded USB drive, or a loaded SD card. The procedure for deleting an application file or a font file is the same.

1. Press Terminal Settings>File Management>Delete Files>Delete Applications or Delete Fonts.

2. Press Source to select the storage location of the application or font file you want to delete:
 - Internal Storage – nonvolatile memory of the terminal
 - External Storage 1 – SD card loaded in the card slot of the terminal
 - External Storage 2 – USB drive connected to a USB host port

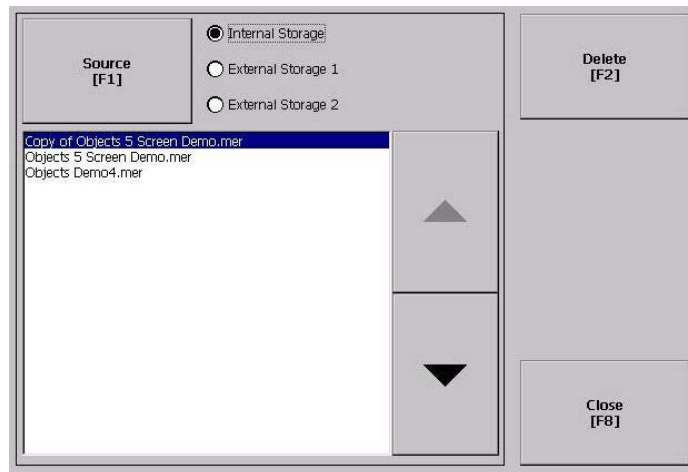

3. Select a file from the list.
4. Press Delete.
5. Select Yes or No when asked if you want to delete the selected application or font file from the storage location.

Delete Log Files

You can delete generated log files, alarm history files, and alarm status files from the System Default location on the terminal.

1. Press Terminal Settings>File Management>Delete Files>Delete Log Files.
You are asked to confirm the deletion of the files.

Do you want to delete all of the FactoryTalk View ME Station Log Files?

2. Select Yes or No.

Log files not in the System Default location are not be deleted.

Copy Application File or Font File

You can copy FactoryTalk View ME Station application .mer files or font files from one storage location to another in the terminal. The procedure for copying an application file or a font file between storage locations is the same.

1. Press Terminal Settings>File Management>Copy Files>Copy Applications or Copy Fonts.

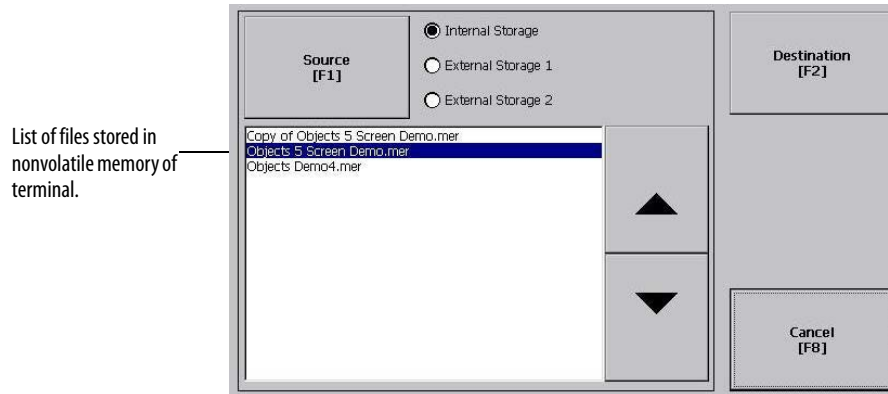

2. Press Source to select the location of the file you want to copy:
 - Internal Storage – nonvolatile memory of the terminal
 - External Storage 1 – SD card loaded in the card slot of the terminal
 - External Storage 2 – USB drive connected to a USB host port
3. Select a file from the storage location.
4. Press Destination on the same dialog box.

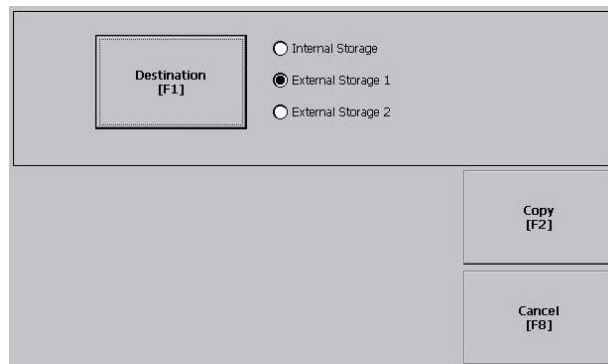

5. Press Destination to select the location to copy the file. The destination must be different than the source location.
6. Press Copy to copy the selected file to the destination. If the file exists, you are asked if you want to overwrite the file.
7. Select Yes or No.

TIP FactoryTalk View ME Station software looks for .mer files in the My Device\Application Data\Rockwell Software\RSViewME\Runtime\ folder and font files in the \Rockwell Software\RSViewME\Fonts\ folder.

Display Settings

For the terminal display, you can adjust its intensity, view its temperature, configure the screen saver, or enable/disable the screen cursor.

Adjust the Display Intensity

You can modify the intensity of the terminal backlight. You can use the default intensity of 100% or you can change the intensity for runtime operations.

1. Press Terminal Settings>Display>Display Intensity.

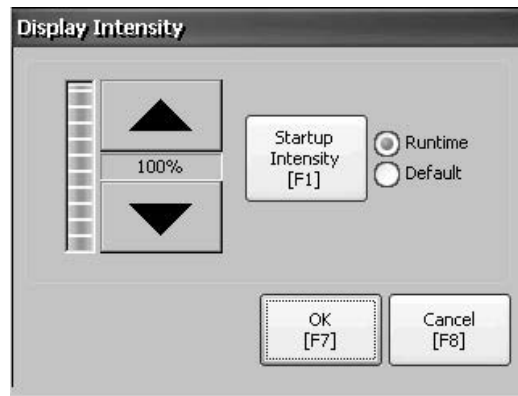

2. Press Startup Intensity to switch between the Default intensity and the Runtime intensity:
 - If you select Runtime, the start-up screens use the runtime intensity.
 - If you select Default, the start-up screens use the default setting, 100%.
3. Increase or decrease the intensity for runtime operations, by pressing the up or down arrow keys.
4. Press OK when done to save the intensity changes.

Configure the Screen Saver

The screen saver on the terminal activates after an idle period at a specific intensity. The default idle timeout is 10 minutes. You can adjust the idle timeout and intensity level for the screen saver, disable the screen saver, and enable or disable the screen saver bitmap.

1. Press Terminal Settings>Display>Screen Saver.

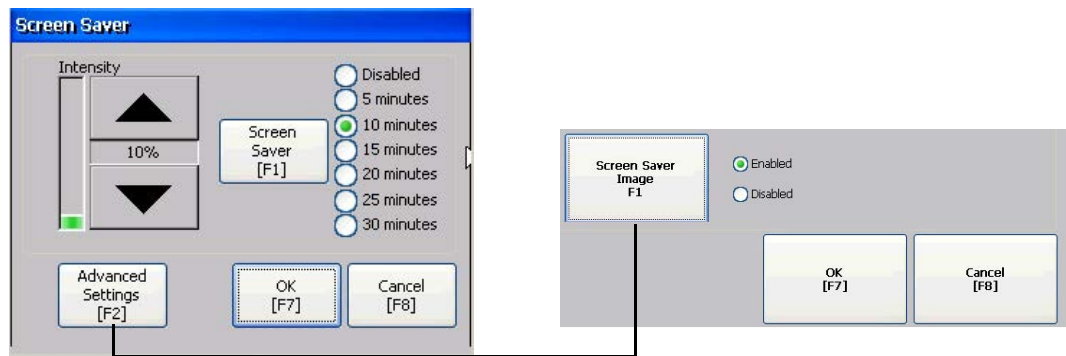

2. Press Screen Saver to select an idle timeout for activating the screen saver. To disable the screen saver, select the Disabled option.
3. Increase or decrease the brightness intensity of the screen saver by pressing the up and down cursor buttons.
4. Press Advanced Settings to access the bitmap option.
 - a. Press Screen Saver Image to enable or disable the screen saver bitmap. Refer to [Screen Saver on page 85](#) for details on how to set the bitmap.
 - b. Press OK to return to the previous.
5. Press OK to exit and return to the terminal settings.

Enable or Disable the Screen Cursor

The terminal has a screen cursor that you can enable or disable.

1. Press Terminal Settings>Display>Cursor.

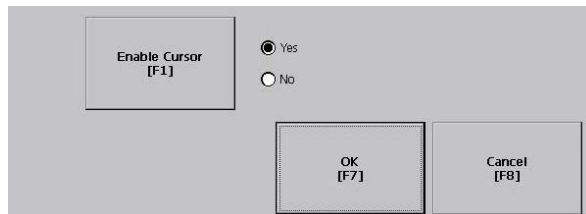

2. Press Enable Cursor to enable or disable the cursor.
3. Press OK to exit and return to Terminal Settings.

Input Device Settings

You can adjust the settings for input devices used by the terminal including the keypad, attached keyboard, mouse, touch screen, and string entry popup.

Configure Keyboard or Keypad Settings

You can adjust settings for keys on an attached keyboard or the terminal keypad.

1. Press Terminal Settings>Input Devices>Keyboard/Keypad.

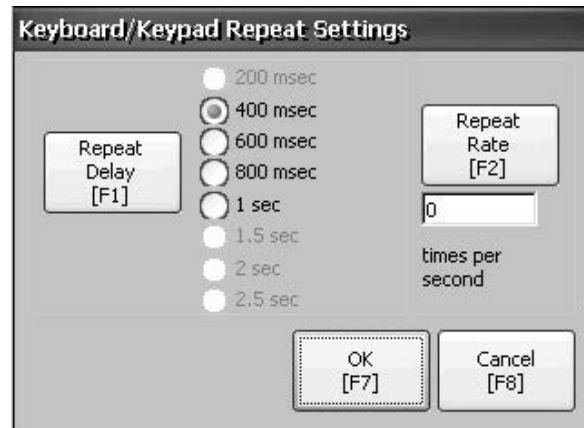

2. Press Repeat Rate to specify the number of times a key is repeated per second when you hold a key down.

Valid values for the keypad are 0 and 2...30. The keyboard is device-dependent but typical values are the same.

3. Press Repeat Delay to select the amount of time that elapses per second before a key is repeated.

Values are device-dependent. Unsupported values are dimmed.

4. Press OK when done.

Set the Sensitivity of the Mouse

You can set and test the sensitivity for both the speed and physical distance between mouse clicks. The process is identical to setting the double-tap sensitivity for the touch screen. See [page 59](#).

To set the mouse sensitivity, press Terminal Settings>Input Devices>Mouse.

Change the Popup for String Entry

You can specify whether to use the standard input panel for data entry or a string popup. The popup keyboard is the default.

1. Press Terminal Settings>Input Devices>String Popup.

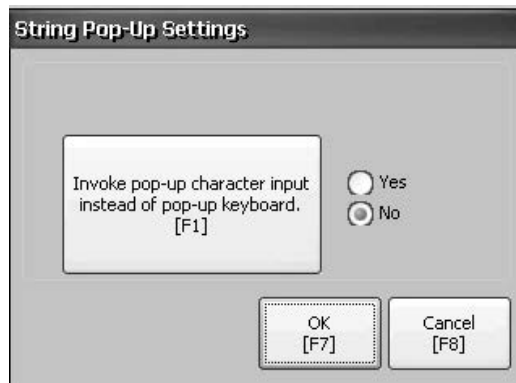

2. Press 'Invoke pop-up character input instead of popup keyboard.' to select the preferred input method for string entry.
3. Press OK.

Calibrate a Touch Screen

Follow these steps to calibrate the touch screen.

IMPORTANT Use a plastic stylus device with a minimum tip radius of 1.3 mm (0.051 in.) to prevent damage to the touch screen.

1. Press Terminal Settings>Input Devices>Touch Screen>Calibration.

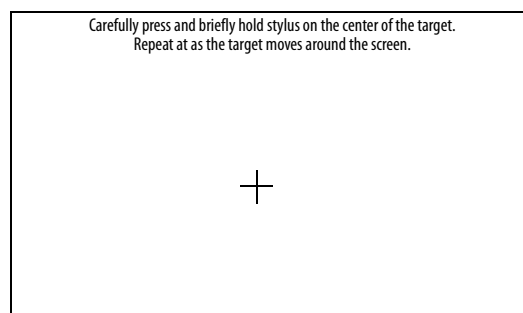

2. Follow the instructions on the screen.

When the calibration is complete, you see a message that indicates new calibration settings have been measured.

| | |
|---|---|
| On terminals with a touch screen | <ul style="list-style-type: none"> • Press the screen to register saved data. • Wait for 30 seconds to cancel saved data and keep the current settings. |
| On terminals with a keypad and touch screen | <ul style="list-style-type: none"> • Press the Enter key to accept new settings • Press the Esc key to keep old settings. |

Set Double-tap Sensitivity for a Touch Screen

You can set and test the sensitivity for both the speed and physical distance between touch-screen presses. The process is identical to setting the double-click sensitivity for the mouse.

1. Press Terminal Settings>Input Devices>Touch Screen>Double Tap Sensitivity.

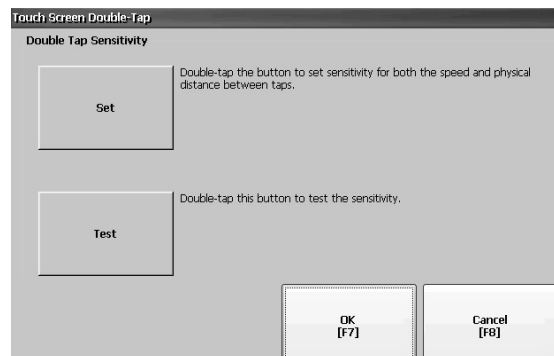

2. Double-tap Set to set the sensitivity of touch-screen presses.
3. Double-tap Test to test the sensitivity of touch-screen presses. The Test button reverses its foreground and background colors.
4. Press OK when done.

Configure Print Options

You can configure settings for printing displays, alarm messages, or diagnostic messages from FactoryTalk View ME Station applications. The setup for printing displays and messages is the same; however, the advanced settings are different.

PanelView Plus 6 Compact terminals are shipped with support for a large selection of Canon, Epson, Hewlett-Packard, and Brother Printers. Printer installation attempts to use USB Plug-and-Play capabilities to the extent that known printers are mapped automatically to the appropriate driver. The printing solution lets applications and users select, manage, and share printers without knowing the underlying details of the printer. Printers that do not configure automatically to the appropriate driver can be installed manually.

Follow these steps to access the print setup.

1. Press a Terminal Settings>Print Setup> option:

- Alarm Print Setup
- Diagnostic Setup
- Display Print Setup

Print Setup displays installed printers that are available to the FactoryTalk View Machine Edition application.

The terminals are not shipped with pre-configured printers, so initially the dialog box appears empty. The appearance of the dialog box depends on what printers you install.

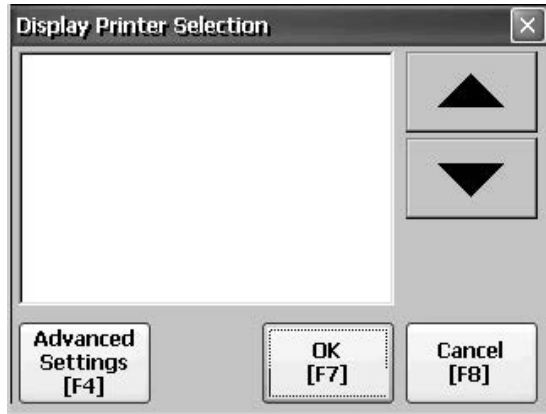

2. Select an installed printer.

TIP

The printer you select must be listed in Printers in the Control Panel.

For a list of supported printers, go to:

<http://www.rockwellautomation.com/knowledgebase> and search the Knowledgebase for ID 111636.

A failed attempt to automatically install a printer is reported in the system event log.

A printer that does not install automatically can be installed manually by using the control panel in Windows Explorer.

3. Press Advanced to access additional settings:
 - Advanced options for printing displays include these settings:
 - Print orientation (portrait or landscape)
 - Draft mode (enable or disable)
 - Color (yes or no)
 - Advanced settings for printing diagnostic and alarm messages determines when to print messages sent to the network or USB port.

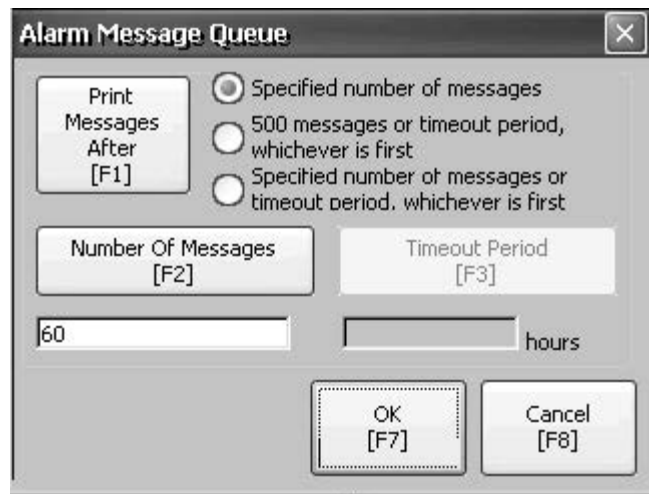

| Print Messages After | Default Value | Example |
|---|-----------------------------------|--|
| Specified number of messages | 60 messages | When the queue has 60 messages, the messages are printed regardless of how long they have been in the queue. You can change the number of messages. |
| 500 messages or timeout period, whichever is first | 168 hours (7 days) | If the queue has 350 messages after 168 hours, the 350 messages are printed. You can change the timeout period. |
| Specified number of messages or timeout period, whichever is first. | 60 messages 168 hours (7 days) | If the queue has 60 messages after 24 hours, then the 60 messages are printed. You can change the number of messages and the timeout period. For example, the number of messages is set to 75 and the timeout period is set to 48 hours: <ul style="list-style-type: none"> • If the queue has 75 messages after 24 hours, then the 75 messages are printed before the set timeout of 48 hours. • If the queue has 15 messages after 48 hours, the 15 messages are printed after the set timeout period. |

4. Press OK when done.
5. Press OK to return to Terminal Settings.

Check Integrity of Application Files

We recommend that you periodically check the integrity of the FactoryTalk View ME Station application file that is loaded in the terminal and the runtime files. All errors, warnings, and information messages generated by these files are logged to a file. You can periodically view the log and clear all items from the log.

1. Press Terminal Settings>File Integrity Check.

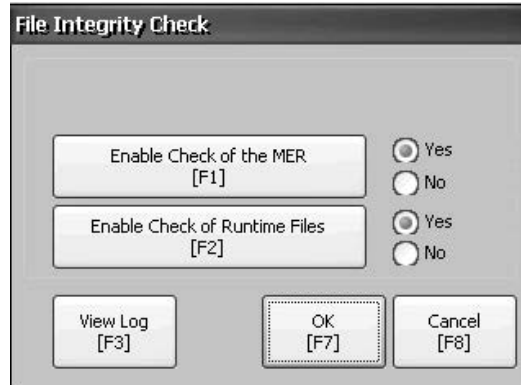

2. Press either of the Enable options to enable or disable file integrity checks:
 - Enable Check of the MER
 - Enable Check of the Runtime Files

By default, integrity checks are automatically performed on the application .mer file and runtime files. If you disable either of these functions, the files are not checked and the log file is not updated.

3. Press OK to save changes.

Follow these steps to view the file integrity check log.

1. Press View Log from the File Integrity Check dialog box.

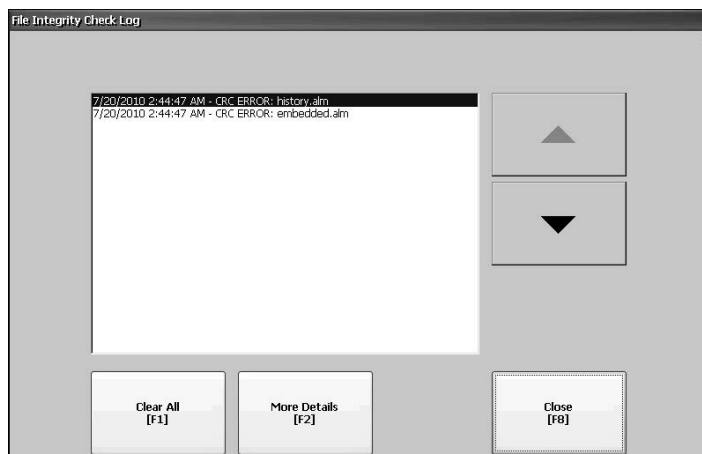

2. Select an event and press More Details to display details for a specific file check event.
3. Press Clear All to clear all details from the log.
4. Press Close to return to previous dialog box.

Configure Diagnostics

You can configure diagnostics for a target computer. To access diagnostics, press Terminal Settings>Diagnostic Setup from the Configuration Mode dialog box. You see a tree view of diagnostic nodes.

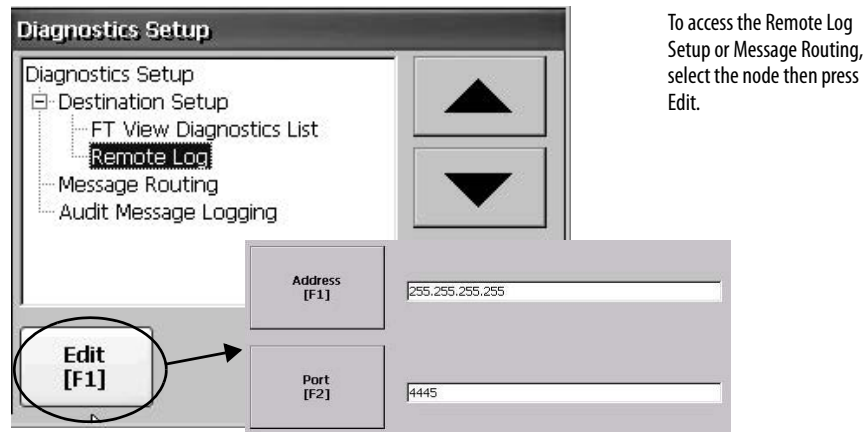

The Remote Log Destination forwards received messages to a Windows computer running diagnostics. The location is determined by the IP address and port number.

| Field | Description | Valid Values |
|---------|--|-----------------|
| Address | Address of the remote Windows computer. | xxx.xxx.xxx.xxx |
| Port | The port used to communicate with the remote Windows computer. | 4445 (default) |

The Message Routing dialog box lets you access these dialog boxes:

- Remote Log
- FactoryTalk View Diagnostics List

Each dialog box shows a list of messages that can be sent to that destination. The list shows the status of each message type. Press On/Off to turn a message type on or off. A message type is enabled if it has a checked box.

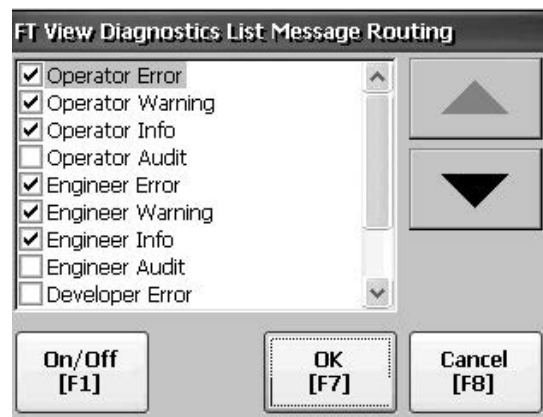

The Audit Message Logging dialog box lets you log messages as Audit or Information when Edit is pressed.

View and Clear the System Event Log

The System Event Log displays warnings, errors, and events logged by the terminal. The log provides a time stamp of when each event occurred and text describing the event. If the event log is full when a new event occurs, the oldest entry is removed to accommodate the new event.

1. Press Terminal Settings>System Event Log.

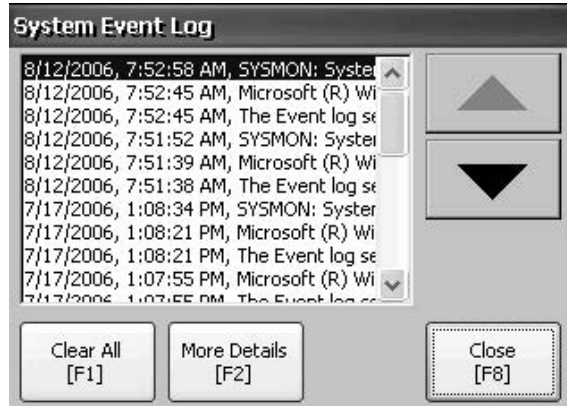

2. Select an event and press More Details to display the details for that event.
3. Press Clear All to clear all events in the log.
4. Press Close.

System Information

You can view terminal and firmware revision information for software installed on a terminal. This information can be useful during troubleshooting.

View Terminal Information

This read-only information is provided for the terminal:

- Total power on time in minutes
- Battery voltage and battery state
- Memory allocated and used on terminal
- RAM memory used during runtime

Follow these steps to display terminal information.

1. Press Terminal Settings>System Information>Terminal Information.

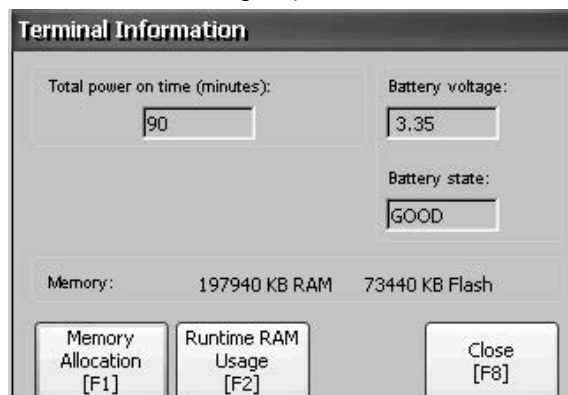

- The CPU temperature must be less than 95 °C (203 °F).
- The battery voltage must be at least 2.75V DC.

| Battery State | Description |
|---------------|---|
| Good | Good battery condition. |
| Failing | Low battery. Replace the battery. |
| Bad | Battery is missing or bad. Replace the battery. |

2. Press Memory Allocation to view the following memory data:
 - Amount of allocated program memory
 - Amount of program memory in use
 - Amount of available nonvolatile memory

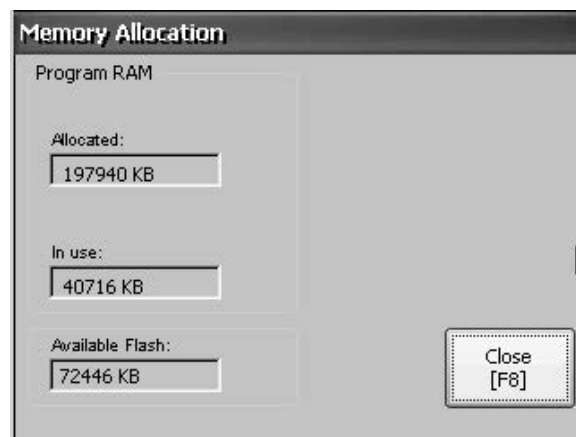

3. Press Close to return to previous dialog box.
4. Press Runtime RAM Usage to troubleshoot runtime anomalies by showing the amount of RAM used by your application at runtime.

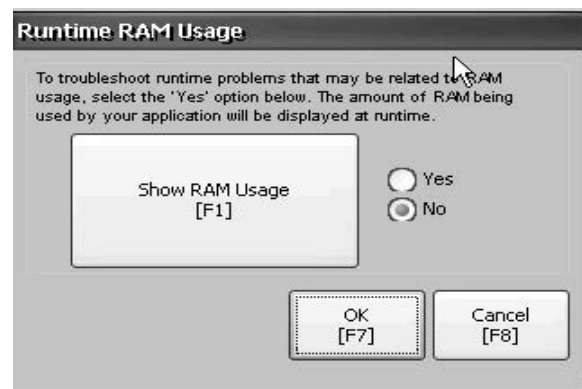

5. Press OK to return to previous dialog box.
6. Press Close until you return to terminal settings.

Display FactoryTalk View ME Station Information

You can display the firmware and version information for installed system components on your terminal and technical support information.

1. Press Terminal Settings>System Information>About FactoryTalk View ME Station.

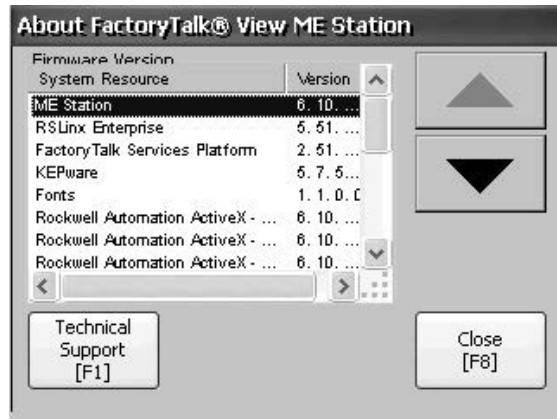

2. Press Technical Support to display the support phone number and website for your terminal.
3. Press Close until you return to terminal settings.

Enable or Disable the Alarm Display

Each new alarm that occurs on the terminal is displayed in the alarm display or banner. When the newest alarm is acknowledged by the operator, you can choose to close the alarm display or leave it open. By default the alarm display is closed.

1. Press Terminal Settings>Alarms.

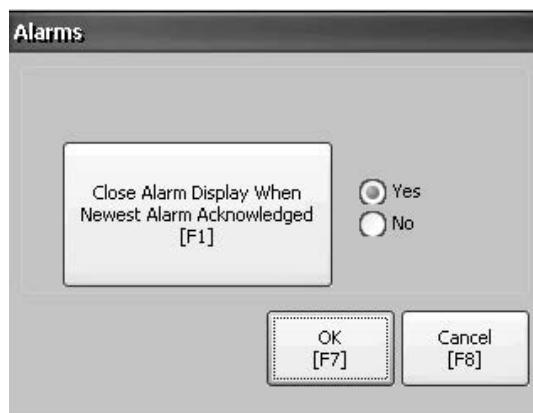

2. Press Yes or No:
 - Yes, the default option, closes the alarm display each time the operator acknowledges the newest alarm.
 - No leaves the alarm display open after the operator acknowledges the newest alarm.
3. Press OK.

Time and Date Settings

You can change the date, time, time zone, and regional settings for terminal operations.

Change the Date for Terminal Operations

Follow these steps to adjust the date for terminal operations.

1. Press Terminal Settings>Time/Date/Regional Settings>Date.

The current date appears in the Year, Month, and Day fields.

2. Press Year, Month, and Day to change the values.

| Field | Description | Valid Values |
|-------|---|--------------|
| Year | The current year in a four-digit format. | 1980...2099 |
| Month | The current month. | 1...12 |
| Day | The current day. The day of the month is validated. | 0...31 |

3. Press OK when done.

Change the Time for Terminal Operations

Follow these steps to adjust the time for terminal operations.

1. Press Terminal Settings>Time/Date/Regional Settings>Time.

The current time appears in 24-hour format in separate Hour, Minute, and Second fields.

2. Press Hour, Minute, and Seconds to change the values.

| Field | Description | Valid Values |
|---------|---------------------------------------|--------------|
| Hour | The current hour in 24-hour format. | 0...23 |
| Minute | The current minute in 24-hour format. | 0...59 |
| Seconds | The current second in 24-hour format. | 0...59 |

3. Press OK when done.

Change the Time Zone for Terminal Operations

You can view or modify the current time zone that is installed on the terminal. Time zones are installed as a part of the operating system. Changing the time zone adjusts the current time and date to match the new time zone.

1. Press Terminal Settings>Time/Date/Regional Settings>Time Zone.



2. Press the up or down cursor to select a time zone.

| Language | Default Time Zone |
|----------|---|
| English | (GMT -05:00) Eastern Time (US and Canada) |
| French | (GMT +01:00) Brussels, Copenhagen, Madrid, Paris |
| German | (GMT +01:00) Amsterdam, Berlin, Bern, Rome, Stockholm, Vienna |
| Japanese | (GMT +09:00) Osaka, Sapporo, Tokyo |

If the selected time zone supports daylight savings, you can press Daylight Savings.

3. Press Daylight Savings to enable or disable daylight savings for the selected time zone.

Daylight savings is set to Yes for all time zones except for Japanese, which does not support daylight savings. Daylight savings changes are not permanently applied until you close the Time Zone dialog box.

4. Press Use Daylight Savings to select Yes or No.

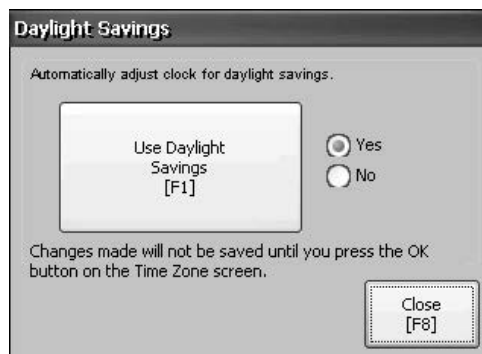

5. Press Close when done.
6. Press OK to return to previous dialog box.

Regional Settings

You can adjust regional settings for a specific language installed on the terminal, including the date, time and numeric formats. Regional settings are accessed by pressing Terminal Settings>Time/Date/Regional Settings>Regional Settings. The current language is shown at the bottom of the Regional Settings dialog box.

Select a Language

Before you can modify regional settings for a language, you need to select a language installed on the terminal. Languages are installed as a part of the operating system.

1. Press Terminal Settings>Time/Date/Regional Settings>Regional Settings>Language.

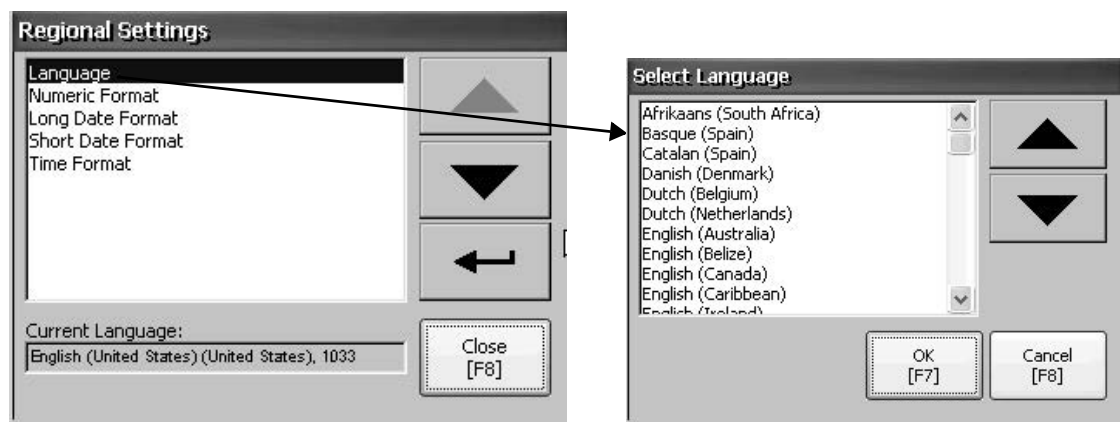

2. Select a language by pressing the up and down cursor keys.
3. Press OK.
The selected language shows under Current Language on the Regional Settings dialog box.

Change the Decimal Separator for Numeric Formats

You can change the decimal separator used in numerics for the current language. The default decimal separator is a period.

1. Press Terminal Settings>Time/Date/Regional Settings>Regional Settings>Numeric Format.

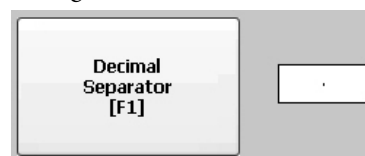

The field shows the default decimal separator. The field accepts a separator up to three characters.

2. Enter up to three characters for the new separator, then press OK.

Change the Time Format for a Language

Follow these steps to change the time format for the selected language.

1. Press Terminal Settings>Time/Date/Regional Settings>Regional Settings>Time Format.

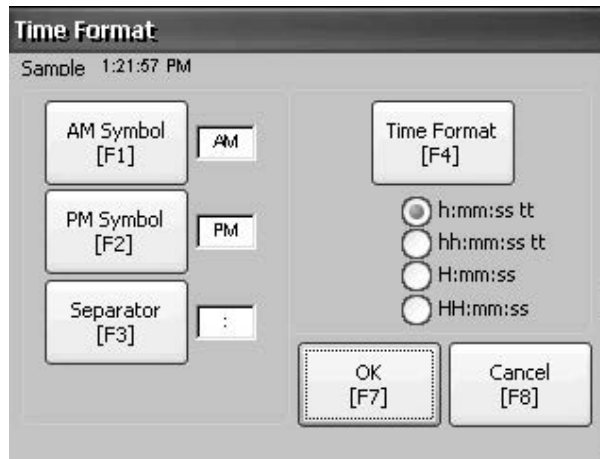

The current time is shown in the currently selected format.

2. Press the appropriate selections to adjust the formats.

| Field | Description | Example |
|-------------|--|---|
| Time Format | h:mm:ss tt (default) h = hour, no leading zero tt = AM or PM symbol | 7:23:02 AM or 1:13:31 PM 11:43:59 AM |
| | hh:mm:ss tt hh = hour with leading zero tt = AM or PM symbol | 07:23:02 AM or 01:13:31 PM 11:43:59 PM |
| | H:mm:ss H = hour in 24-hour format, no leading zero | 7:03:42 or 1:13:32 23:43:59 |
| | HH:mm:ss HH = hour in 24-hour format with leading zero | 07:03:42 or 01:13:22 23:43:59 |
| AM Symbol | Characters to indicate AM. If the time format is set to h:mm:ss tt or hh:mm:ss tt, you can modify the AM symbol. | AM (default) 12 character max |
| PM Symbol | Characters to indicate PM. If the time format is set to h:mm:ss tt or hh:mm:ss tt, you can modify the PM symbol. | PM (default) 12 character max |
| Separator | Characters that separate fields in time format. | : (default) 3 character max |

3. Press OK.

Change the Short Date Format for a Language

Follow these steps to change the short date format for the selected language.

1. Press Terminal Settings>Time/Date/Regional Settings>Regional Settings>Short Date Format.

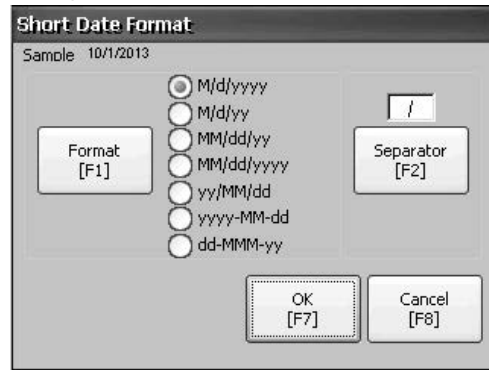

The Sample area shows the current date in the selected format.

2. Press Format to select an available format.

The date is updated in the Sample area as you make selections.

3. Press Separator to change the separator for the date elements.

The separator can be three characters. The default separators are – or /.

4. Press OK when done.

Change the Long Date Format for a Language

Follow these steps to change the long date format used by the selected language.

1. Press Terminal Settings>Time/Date/Regional Settings>Regional Settings>Long Date Format.

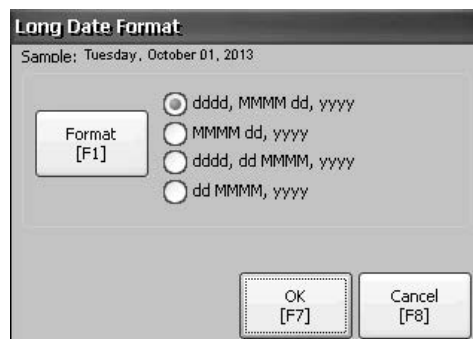

The Sample area shows the current date in the selected format.

2. Press Format to select an available format.

The date is updated in the Sample area as you make selections.

3. Press OK when done.

Font Linking

Font linking lets you run a translated application on the terminal by linking a font file to the base font (for example, linking a Chinese font file to the base font Arial).

For more details on preinstalled terminal fonts and additional fonts available for downloading, see [Fonts Resident on Terminal on page 155](#).

Press Terminal Settings>Font Linking to access this function.

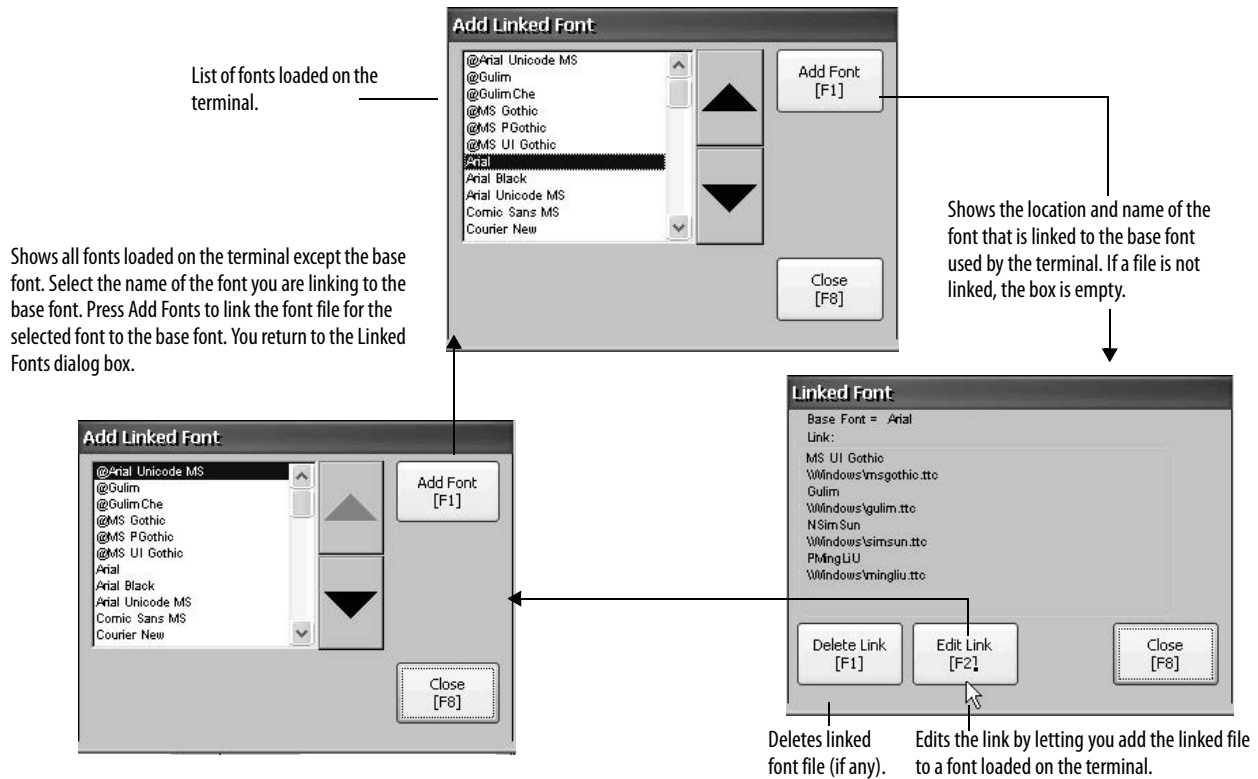

Windows CE Operating System

| Topic | Page |
|------------------------------|------|
| Windows CE 6.0 Features | 73 |
| Windows Explorer | 76 |
| Taskbar | 76 |
| Input Panels | 76 |
| Windows Control Panel | 77 |
| Backup and Restore | 78 |
| Hardware Monitor | 81 |
| Touch Properties | 83 |
| Keypad Properties | 83 |
| Display Properties | 84 |
| Logo Manager | 86 |
| System Information | 87 |
| User Accounts | 90 |
| Services | 91 |
| Network Server Configuration | 92 |
| Printer Support | 101 |
| PDF Reader | 104 |

Windows CE 6.0 Features

The terminals run the Windows CE 6.0 operating system (OS) providing the following shell and user interface features:

- Command shell
- Command processor
- Console window
- Windows Explorer shell
- Mouse and touch screen support
- Common dialog box
- Control panel
- Network user interface
- Soft keyboard input panels
- Adobe PDF reader

- VNC server and client viewer

The platform distributes two VNC client viewers:

- Vncviewer.exe in the \Windows folder on the terminal can be deployed to a personal computer for connecting, viewing, and controlling the Windows CE terminal (PanelView Plus 6 Compact).
- Another viewer is available on the terminal to establish a VNC connection between two PanelView Plus 6 Compact terminals. To access this VNC client, choose Start>Programs>VNC Viewer.

TIP The Windows Explorer shell supports right-click functionality. A touch screen press for one second or longer produces a right-click.

Application Support

The Windows CE 6.0 operating system provides the following application support in both the OS and the Software Development Kit (SDK):

- .Net Compact Framework, version 3.5 or later
- C++ libraries and runtimes
- Component services DCOM/COM/OLE
- Message queueing MSMQ
- MSXML, version 3.0 or later
- MFC for devices, version 9.0 or later
- ATL
- ActiveSync
- CAB file installer/uninstaller
- Toolhelp API
- Error reporting (generator, transfer driver, control panel)

Scripting Support

The Windows CE 6.0 operating system supports these scripting features:

- Batch/command (BAT and CMD files)
- JScript
- VBScript
- CSScript

Network Support

The Windows CE 6.0 operating system supports these network features:

- Winsock support
- Network utilities - ipconfig, ping, route
- Network Driver Architecture (NDIS)
- Windows Networking API/Redirector
- Wired Local Area Network, 802.3, 802.5

Server Support

This table lists servers supported by the Windows CE 6.0 operating system.

Table 24 - Windows CE 6.0 Server Support

| Server | Default State | Description |
|------------------|---------------|--|
| Web server | Enabled | The web server delivers content, such as web pages, by using the HTTP protocol over the Web. |
| FTP server | Enabled | File Transfer Protocol (FTP) is a standard network protocol for exchanging files over the Internet (TCP/IP-based network). |
| UPnP server | Enabled | Universal Plug and Play (UPnP) is a set of networking protocols that lets devices install and connect seamlessly to a network. |
| File server | Enabled | A network protocol that provides shared access to files, printers, serial ports, and miscellaneous communication between computers on a network. |
| VNC server | Disabled | Virtual Network Computing (VNC) is a graphical desktop sharing system used to remotely control another computer. It transmits keyboard/mouse events from one computer to another, over a network. |
| ViewPoint server | Enabled | A web-server application that provides remote users access via a web browser to the FactoryTalk View Machine Edition HMI application that is running on the terminal. ViewPoint software is a Rockwell Automation product. |

Windows Explorer

From the desktop, you can access Windows Explorer in several ways:

- Open My Device icon on the desktop.
- Choose Start>Programs>Window Explorer.

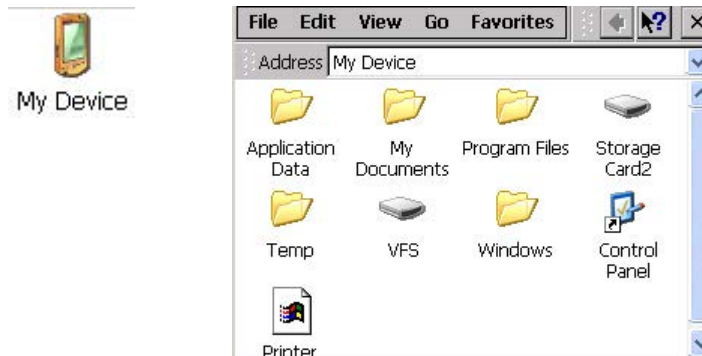

Besides the typical system folders, a few folders contain items that are specific to the PanelView Plus 6 Compact terminals.

| Folder | Content |
|---------------------------|--|
| Application Data | Contains FactoryTalk View Machine Edition application files. Path: \Application Data\Rockwell Software\RSViewME\Runtime |
| VFS (Virtual File System) | Contains firmware files and back-up/restore files for the current system image. Path: \VFS\Platform Firmware |

Taskbar

The taskbar has icons to access the Start menu, terminal IP information, current language and time, desktop access, input panels, and open programs.



You can turn the taskbar on or off by choosing Start>Settings>Taskbar and Start Menu then checking or clearing the Auto Hide checkbox.

TIP On touch screen terminals, touch the bottom of the display to recover the taskbar in Auto Hide mode.

Input Panels

Different soft keyboards or input panels are available for entering data. You can access these input panels from the taskbar.



- Keyboard and large keyboard
- CHT Chajei (Chinese)
- CHT Phonetic (Chinese)
- MS Kana (Japanese)
- MS Roma (Japanese)
- No IM - no input method selected (default)

TIP You can hide the view of an input panel from the taskbar by choosing the No IM option.

Windows Control Panel

The Windows control panel is the desktop interface for configuring a terminal. You can set system-wide and terminal properties, such as network configuration, screen saver configuration, and touch screen calibration.

TIP Most of the terminal settings are available in FactoryTalk View ME Station Configuration mode.

The language of the control panel items is based on the language set for the operating system. English is the default.



You can access the control panel in several ways:

- Choose Start>Settings>Control Panel.
- Open My Device on the desktop, then open the Control Panel.

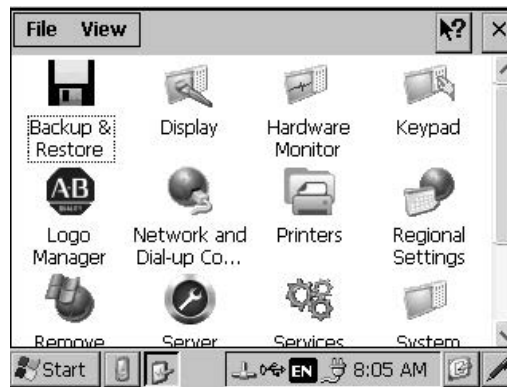

Only the control panel dialog boxes specific to the terminal are covered in this chapter.

TIP From the View menu, you can change the size of the icons or see a brief description of each icon.

TIP Many of the control panel dialog boxes have scroll bars for viewing information on a small display, however, most examples show the full view for clarity.

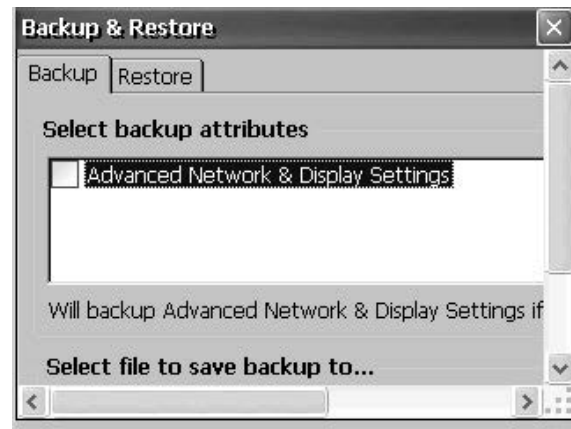

Backup and Restore



Backup and Restore dialog box lets you back up the current system image on the HMI terminal, then restore that image to the same terminal, or clone it to other terminals. This function is intended for OEMs who want to back up a terminal image, then clone or copy that same image to multiple terminals.

A typical backup includes the following:

- File system
- Firmware image
- Windows registry

Additional user configuration data is included in the backup if you check Advanced Network & Display Settings.

Table 25 - Advanced Network and Display Settings

| Network Parameters | Terminal Specific Parameter |
|--------------------|--|
| Ethernet network | <ul style="list-style-type: none"> • DHCP-enabled or fixed IP address with subnet mask and gateway • Primary and secondary DNS • Primary and secondary WNS • Speed and duplex settings |
| USB network | USB IP address and subnet mask, Gateway, DHCP-enabled or fixed IP address |
| Network | Device name |
| Display | <ul style="list-style-type: none"> • Display brightness • Screen saver dimmer timeout |

You can back up the terminal image to a file on a USB drive or SD card.

Follow these steps to perform a backup.

1. Insert a USB drive or SD memory card into the appropriate slot of the terminal.
2. In the control panel, double-click the Backup & Restore icon.
3. Click the browse ... button on the Backup tab.

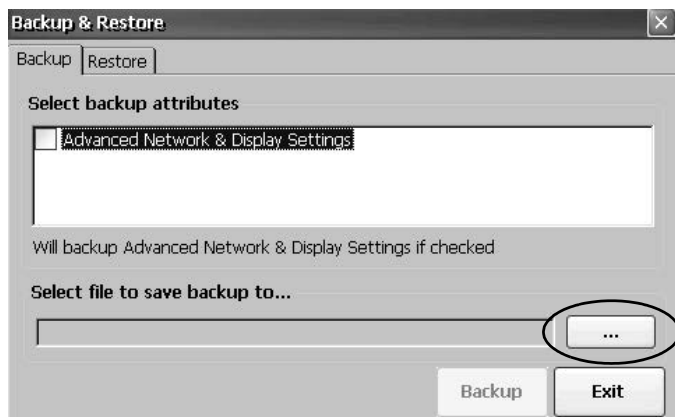

4. Select the location for the back-up file:
 - USB Storage if using a USB drive
 - Storage Card2 if using an SD card
 - Target folder if backing up to terminal
5. Type a name for the back-up file.
All back-up files have the .pvb file type.
6. Click OK.

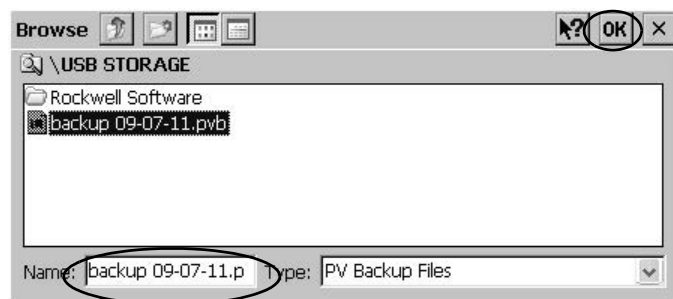

- Click Backup to start the process.

A progress bar shows the status of the backup.

The backup can take a few minutes. You receive notification when the backup completes successfully.



- Click OK.

If the file exists, you are asked if you want to overwrite the current file.

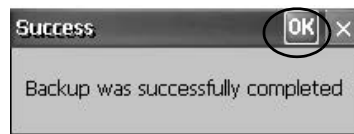

- Click Exit to close the Backup & Restore dialog box.

TIP

You can verify that .pvb file was successfully created by double-clicking My Device and selecting the target location for the backup.

Follow these steps to restore or clone a back-up image to a terminal from a USB drive or SD card.

- Insert the USB drive or SD memory card into the appropriate slot on the target terminal.
- In the control panel, double-click Backup & Restore.
- Click the Restore tab.
- Click the ... browse button to select the back-up file to restore.

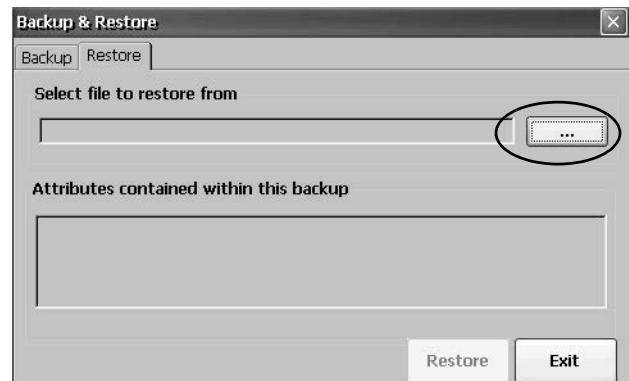

- Select the location of the back-up file:
 - USB Storage if using a USB drive
 - Storage Card2 if using an SD card
 - Target folder on terminal containing .pvb file

This example shows \USB Storage as the location.
- Select the .pvb back-up file to restore.
- Click OK.

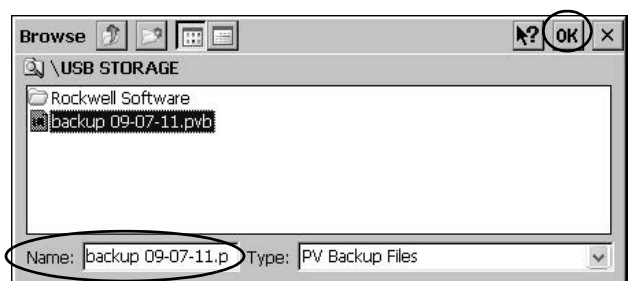

8. Click Restore.

The restore automatically includes advanced network and display settings if this option was checked when the backup was performed.



9. Click Yes to start the restore.

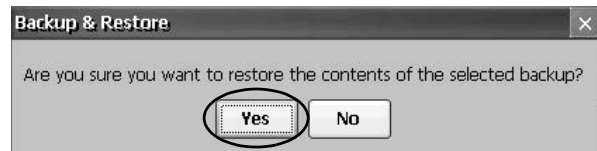

The terminal starts the restore process. It can take a few minutes.

IMPORTANT Do not remove the USB drive or SD card, or power off the terminal during the restore. This could corrupt the firmware.

If the restore fails, you need to reset the terminal from the maintenance menu.

Refer to [Maintenance Operations on page 151](#) for details.



When the restore has completed successfully, the terminal restarts.

Hardware Monitor



The PanelView Hardware Monitor provides status and troubleshooting information for the terminals including running processes, system event log details, and monitoring of battery voltages, temperatures, and system usage, for example, CPU and memory loading.

Processes

The Processes tab of the Hardware Monitor shows all processes currently running on the terminal and memory usage of each process.

| ProcessName | ProcessId | Thr | BaseAddr | He |
|-------------|-----------|-----|----------|-----|
| NK.EXE | 00400002 | 92 | 80023000 | 340 |
| udevice.exe | 01F70006 | 7 | 00010000 | 190 |
| udevice.exe | 0103000A | 1 | 00010000 | 430 |
| udevice.exe | 02230002 | 1 | 00010000 | 490 |
| udevice.exe | 02010006 | 1 | 00010000 | 140 |

Memory load 3444432896/105897984 [7%]

System Event Log

The System Event Log tab of the PanelView Hardware Monitor displays warnings, errors, and events logged by the terminal.

| Type | Date | Time | Category | Ms |
|-------------|-----------|------------|----------|-----|
| Information | 8/12/2006 | 7:52:58 AM | PVP | 167 |
| Information | 8/12/2006 | 7:52:45 AM | None | 655 |
| Information | 8/12/2006 | 7:52:45 AM | None | 655 |

Cpu load 4%

The log provides a date and time stamp of when each event occurred and text describing the event. The maximum size of the log is 1 MB, approximately 4,000 records. If the log exceeds 1 MB, the oldest 512 KB of information is removed:

- The Export Log button lets you export the event log to a CSV file (*.csv) in the \Windows folder with the default file name, SystemLog.csv.
- The Clear Log button lets you clear all events from the log.
- The Details button lets you view more details for a selected event.

Monitors

The Monitors tab of the PanelView Hardware Monitor provides continuous voltage, temperature, and load information for the terminal.

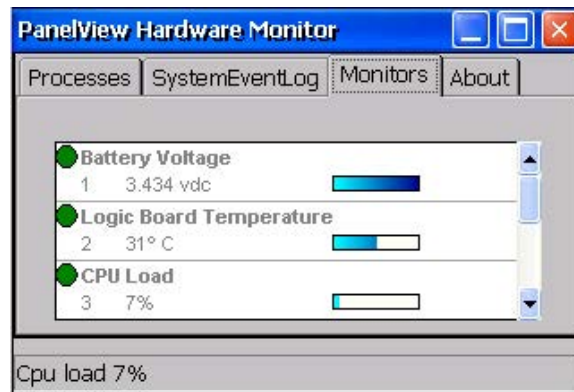

Battery Voltage

The Monitors tab gives a visual status and voltage reading of the battery for the real-time clock. The battery voltage is updated at powerup and then every hour.

Table 26 - Battery Conditions

| Condition | Battery |
|-----------|--|
| Depleted | Less than 2.0V indicates a dead battery or no power. |
| Low | 2.0...2.74V |
| Normal | 2.75V or higher |

A low or depleted battery is recorded in the systems events log.

Temperatures

The Monitors tab provides a visual status and current temperature of the logic board in the terminal. The temperature is updated every 10 seconds.

Table 27 - Temperature Conditions

| Condition | Logic Board |
|-----------|---------------------------|
| Low | – |
| Normal | 25...94 °C (77...201 °F) |
| High | 95 °C (203 °F) and higher |

A failed temperature sensor is recorded in the system events log.

Keypad Properties



Use the Keypad and Keyboard dialog boxes to adjust settings for the membrane keypad of your terminal or an attached USB keyboard. The Keyboard icon is always present. Keypad appears only if your terminal has a keypad.

Repeat Tab

The Repeat tab on the Keypad/Keyboard Properties dialog box enables and disables the character repeat behavior of keys on the keypad or attached keyboard.

When character repeat is enabled, you can set the repeat delay and repeat rate of keys. Verify your settings by pressing a key in the test edit box.

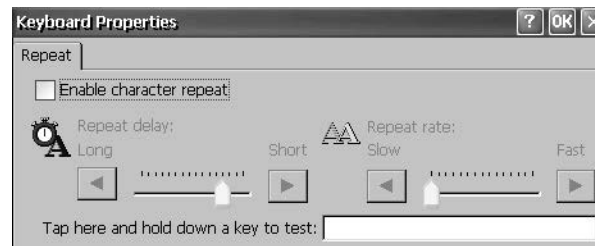

Touch Properties



Touch Properties is accessible only on devices with a touch screen. It lets you calibrate the touch screen and set the sensitivity of touch screen taps.

Calibration

The Calibration tab lets you recalibrate the touch screen if your device is not responding appropriately to taps. Follow the instructions in the dialog box to recalibrate.



Double-Tap

The Double-Tap tab on the Touch Properties dialog box lets you set and test the double-tap sensitivity of the touch screen taps.

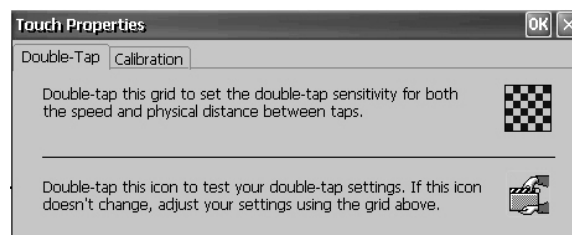

Display Properties



Display

Use Display Properties to control the desktop background image and appearance, the brightness of the backlight, and screen saver settings.

Desktop Background

The Background tab in Display Properties controls the background bitmap on the desktop. The default bitmap is abclocknight.



You can select another image from the pull-down menu or browse the system for a bitmap image. Custom images are in the \Windows folder.

Desktop Appearance

The Appearance tab in Display Properties controls the visual style and colors of the desktop and other window elements.

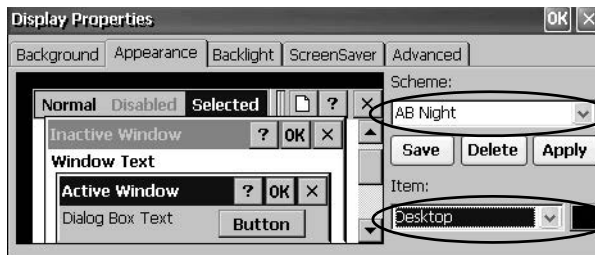

Two custom schemes and images are provided for day or night viewing. When changing schemes, remember to also change the image on the Background tab.

| Scheme | Desktop Color | Background Logo |
|----------|---------------|-----------------|
| AB Day | Blue | abclocknight |
| AB Night | Black | abclockday |

Backlight Intensity

The Backlight tab in Display Properties lets you set the brightness level of the display between 1...100%. At 1%, the display is minimally visible.

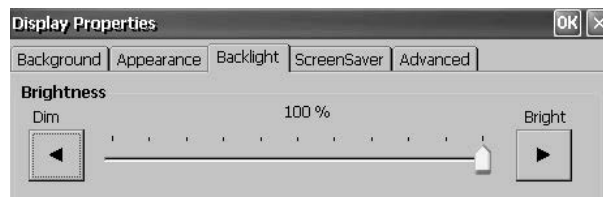

Screen Saver

The screen saver extends the lifetime of the display by dimming the backlight when the terminal is idle. The screen saver activates and displays a moving bitmap at a reduced brightness level after a continuous idle time. When the screen saver is deactivated, the display brightness returns to its normal level.

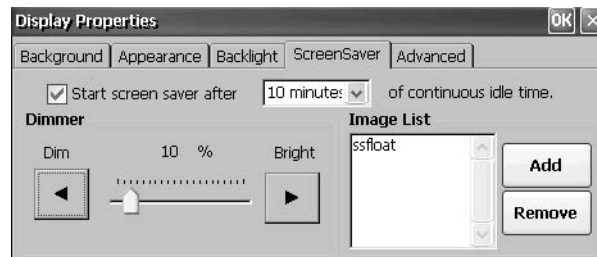

The Screen Saver tab in Display Properties lets you perform these operations:

- Enable the screen saver by using a specified idle timeout. The default idle time is 10 minutes.

When the screen saver is activated, the dimmer controls the backlight intensity level. You set the brightness level of the dimmer in the range 0...100%. The default dimmer intensity is 10%. At 0%, the backlight is off and the display is dark.

- Browse the system for a bitmap to be displayed by the screen saver at a nonzero brightness level. The default screen saver is SSFloat.bmp. Click Add or Remove to change the screen saver bitmap. The system recognizes bitmaps stored in the \Windows folder.
- Disable the screen saver by clearing the Start screen saver checkbox.

Cursor

The Advanced tab in Display Properties lets you enable or disable the visible cursor that you see on the display. The cursor is visible by default.

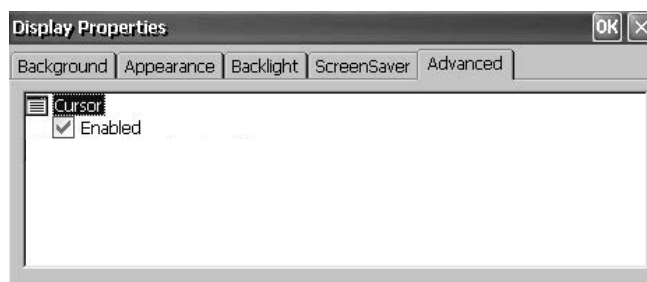

Logo Manager



Use the Logo Manager to change the logo that appears on the splash screen at startup and the default screen saver image. The default image is the Allen-Bradley logo (ablogo.bmp).

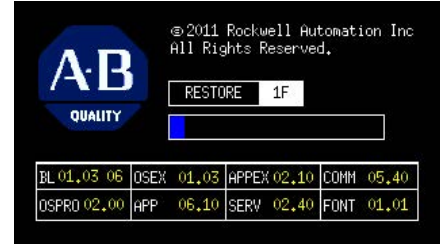

The logo can be a .bmp, .jpg, .gif, or .png image. For best results, it is recommended that the logo be created as a 90 x 90 pixel, 16-bit color image.

Before applying the new logo, you can do the following:

- Preview the logo on the splash screen.
- Resize the image to fit the fixed area on the splash screen.

Follow these steps to apply a new logo to the splash screen and screen saver.

1. Double-click the Logo Manager icon.
The Logo Manager opens with the current logo.
2. Click Load.
3. Select the location of the new image you want to load:
 - A folder
 - Storage Card2 - SD card
 - USB storage - USB drive
4. Select the image file to load.
5. Verify the file type is correct.
6. Click OK.

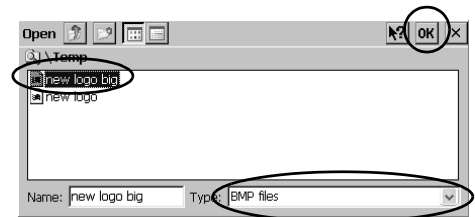

The new logo appears in the Logo Manager dialog box.

7. Check 'Preview entire screen' to view the logo on the splash screen.

If the logo is truncated or too small, check 'Stretch/shrink image to fit' to resize the logo to fit in the area.

8. If satisfied with the preview, click Apply.

A dialog box confirms the splash screen was successfully updated. The default screen saver, sfloat.bmp, is also updated with the new image.

9. Click OK, then click Exit to close the Logo Manager.

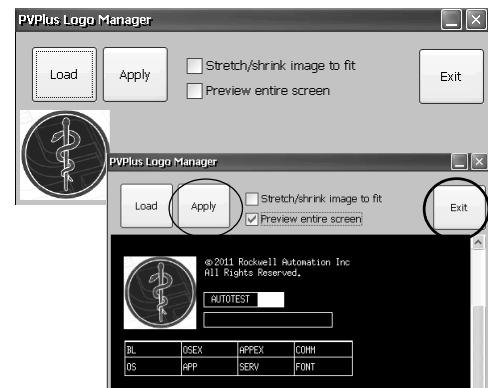

System Information



The System Information dialog box provides tabs to view and set system-wide properties for your terminal.

General Information

The General tab of the System Information dialog box shows the current version of the Windows CE operating system, the processor type and speed, and RAM memory on terminal.



Startup Options

The Startup Options tab of the System Information dialog box lets you set these options at startup:

- Show or hide battery warning
- Launch the platform as open or closed system
- Disable or enable Safe mode request
- Show or hide system watchdog errors



Battery Warnings

If the battery is low, missing, or dead, a warning displays each time the terminal starts up.

- TIP**
- The terminal can be operated without a battery if it is not required that the time and date be accurate.
 - When replacing the battery, you can verify the accuracy of the system date and time from the desktop control panel or the terminal settings in FactoryTalk View ME Station Configuration mode.



You have three options for handling the battery warning.

| Battery Warning Startup Options | Description |
|--|--|
| Always show at startup (continue with startup) | Shows the battery warning at startup with FactoryTalk View ME Station software running behind it. This is the default. |
| Always show at startup (halt startup) | Shows the battery warning at startup but halts the startup or boot process until you press OK. |
| Never show at startup | Hides the battery warning at startup. |

Shell Options

Use the Shell options to launch an open or closed desktop at startup or to set the visual appearance of button controls.



| Shell Startup Options | Description |
|--------------------------------|---|
| System Type | <p>Launches the terminal as an open or closed system at startup:</p> <ul style="list-style-type: none"> Open - launches the Windows CE desktop on startup. Closed (default) - launches FactoryTalk View ME Station Configuration mode on startup. <p>You can also allow or restrict desktop access within FactoryTalk View ME Station Configuration mode by pressing Terminal Settings>Desktop Access Setup. Refer to Desktop Access on page 42.</p> |
| User Interface Button Controls | <p>Sets the visual appearance of control buttons at startup:</p> <ul style="list-style-type: none"> Windows XP Style (default) Windows 95 Style |

Boot Option

The boot option provides a way for you to enter Safe mode at startup.



| Safe Mode Option | Description |
|--|---|
| Do not detect Safe mode request at startup | Disables Safe mode detection during startup. This is the default. |
| Detect Safe mode request at startup | <p>Displays a small white box in the lower left corner of the terminal display during startup that you can touch or press F1 to enter Safe mode. This lets you bypass a loaded FactoryTalk View ME application and go directly to Configuration mode. If you don't press F1 or touch the white box, the system boots up normally.</p> <p>Another way to enter Safe mode is to access Maintenance mode. Refer to Maintenance Operations on page 151.</p> |

Watchdog Errors

You can show or hide watchdog errors at startup.



| Watchdog Error Options | Description |
|--|---|
| Always show watchdog errors at startup | Shows the fatal watchdog error (error 02) at startup and halts the normal boot process. This is the default. The system launches the maintenance window with the watchdog error displayed. You can continue booting from this window. Refer to Maintenance Operations on page 151 for details. The error is logged to the System Event log. |
| Never show watchdog errors at startup | Hides the errors at startup and logs the error to the system event log. |

Advanced Diagnostics

Advanced diagnostics are for technical support use to diagnose and resolve system errors. They are not for use in a normal production environment.

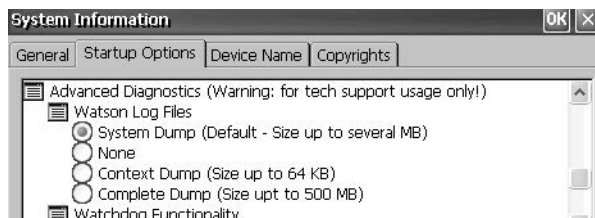

Device Name

The Device Name tab of the System Information dialog box identifies your terminal to other devices on the network by providing a device name and description.



IMPORTANT Device names must be unique. Duplicate names conflict and cause network problems.

User Accounts



User Accounts lets you set up NTLM user accounts that can be used to authenticate client connections when using the FTP, web, and file servers.

TIP NTLM is the authentication protocol used on networks that run Windows operating systems.

A user account consists of a user name and password.

Follow these steps to add a user account.

1. Double-click the User Accounts icon.

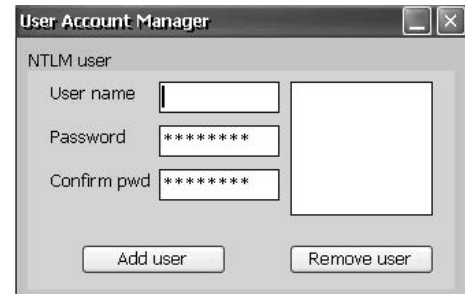

2. Click in the user name field and type a name.

3. Click in the Password field to clear the field and type a password.

Asterisks display as you type the password.

4. Re-enter the password in the Confirm pwd field.

5. Click Add user.

6. Click OK to acknowledge the new user account.

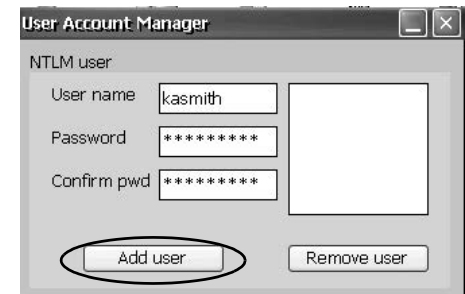

The new user name is added to the user list.

7. Repeat steps 1...6 to add additional user accounts.
8. When done, click X to close the dialog box.

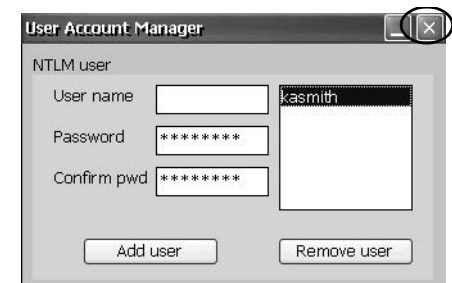

Follow these steps to remove a user account.

1. Select a name in the user name list.
2. Click Remove user.



3. Click Yes to confirm the removal of the selected user account.

The user account is permanently deleted from the user account list.

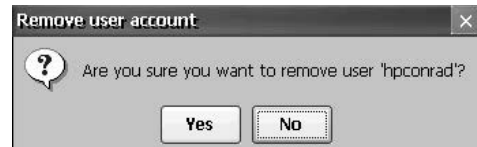

4. Close the User Account Manager by clicking x.

TIP Users entered in authentication lists of FTP, web, or file server configurations are removed when user accounts are deleted.

Services



Services

The Services dialog box shows servers that are supported by the terminal and lets you enable (start) or disable (stop) each server.

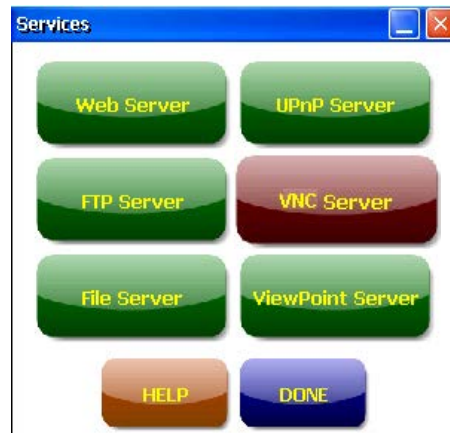

The buttons are color coded except on grayscale terminals:

- Green indicates the server is currently running and automatically started at system startup.
- Red indicates the server is not currently running.
- Gray indicates the server is not available on platform.

To enable or disable a server, press the corresponding button and the color changes accordingly.

Network Server Configuration



The Server Config dialog box in the control panel configures settings used for VNC, FTP, web, KEPServer, and file server activities on an Ethernet network.

VNC Server Configuration

The VNC Server tab in the Network Server Configuration dialog box configures settings used by a client device to view or control the terminal over a VNC connection. The VNC service supports two concurrent client connections.

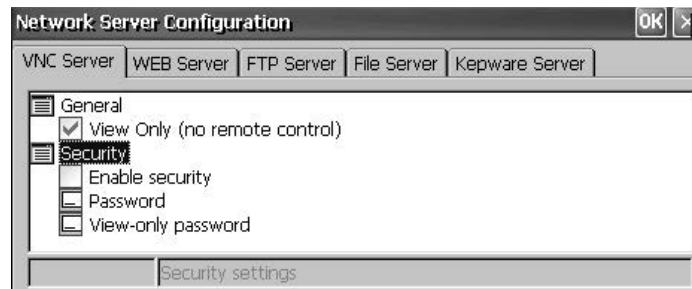

TIP Always click OK to apply new settings. You are asked if you want to restart the service immediately.

The terminal provides two VNC client viewers:

- Vncviewer.exe can be deployed to a personal computer for connecting, viewing, and controlling the VNC server on the terminal. This viewer is in the \Windows folder.
- Another VNC viewer is available on the terminal to establish a VNC connection between two PanelView Plus 6 terminals. To access this client, choose Start>Programs>VNC Viewer.

Table 28 - VNC Server Parameters

| VNC Parameter | Description | Default |
|--------------------|--|-----------------------|
| General | | |
| View Only | Check this option to let users view terminal displays over a VNC connection. Uncheck this option to let users both control and view terminal displays over a VNC connection. If security is disabled, users are not required to enter a password when connecting to the terminal. | Enabled for view only |
| Security | | |
| Enable Security | Check this option to require password protection for VNC connections to the terminal. This means users must enter a valid password before viewing or controlling terminal displays. If you enable security, you must supply a password for one of these parameters: <ul style="list-style-type: none"> • Password - for control and view operations • View-only password - for view only operations | Disabled (Unchecked) |
| Password | Specifies a password a user must enter when establishing a VNC connection to control terminal displays. Select the box, then type a password in the field at the bottom of the dialog box. The password is a maximum of seven characters. Password protection is required to control terminal displays if: <ul style="list-style-type: none"> • View Only is unchecked (allowing control access) • Security is enabled | No password |
| View-only password | Specifies a password a user must enter when establishing a VNC connection to view terminal displays. Select the box, then type a password in the field at the bottom of the dialog box. The password is a maximum of seven characters. TIP: If you uncheck the View Only parameter, you have control and view access to the terminal. With control access enabled, you can restrict one or more users to view-only access by providing a View-only password. View-only password protection is required to view terminal displays if security is enabled: <ul style="list-style-type: none"> • View Only is checked or unchecked • Security is enabled | No password |

VNC Connection Requiring Password for View-only Operations

The default VNC configuration enables view-only access to the terminal without requiring a password. This applies to the VNC viewer that resides on the terminal and the viewer you can deploy to a computer.

This example uses the VNC viewer deployed to a computer to connect to the HMI terminal.

TIP Copy `vcviewer.exe`, in the `\Windows` folder on the terminal, to your computer and install the TightVNC software.

Follow these steps to configure a VNC connection that requires a password to view terminal operations.

1. On the VNC Server tab, check the following:
 - View Only
 - Enable security
2. Select View-only password, then enter a seven-character password in the field that opens.

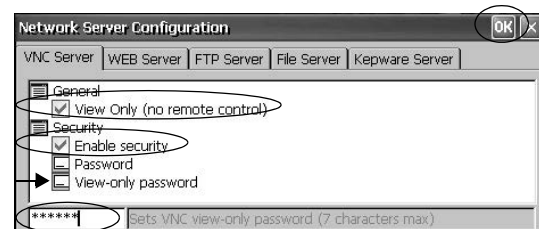

3. Click OK, then restart the service to apply the new settings.

Follow these steps to launch a VNC connection to view terminal operations.

1. From your computer, choose Start>Programs>TightVNC>TightVNC Viewer.
2. Enter the IP address of your terminal and click Connect.



Click the network connection icon in the system tray to view the IP address.

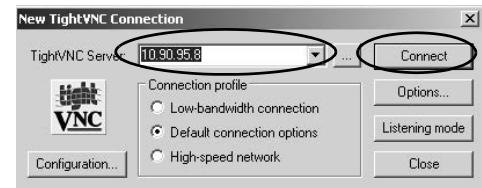

TIP If security is disabled, a password is not required.

3. Enter the View-only password defined in the VNC configuration and click OK.

The PanelView VNC Server opens the current view of the HMI terminal on your desktop. You can view but not control terminal operations.

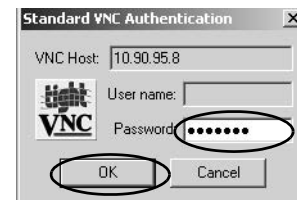

4. When finished, close the PanelView VNC Server.

VNC Connection with Separate Passwords for View and Control Operations

You can configure the VNC server to require separate passwords for view-only and control operations.

This example uses the VNC viewer deployed to a computer to connect to the HMI terminal.

TIP Copy vncviewer.exe, in the \Windows folder on the terminal, to your computer and install the TightVNC software.

Follow these steps to configure the VNC server to require a separate password for view-only and control operations.

1. On the VNC Server tab, do the following:
 - Clear View Only
 - Check Enable security
2. Select Password, then enter a password for control privileges.

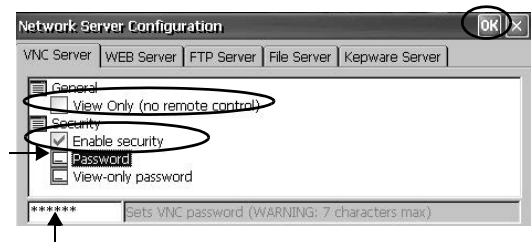

Passwords are a maximum of seven characters.

3. Select View-only password and enter a password for view-only privileges.
4. Click OK, then restart the service to apply the new settings.



Follow these steps to launch a VNC connection to enable control of the terminal.

TIP To launch a VNC connection from your computer that requires password protection for view-only operations, refer to [VNC Connection Requiring Password for View-only Operations on page 93](#) and follow steps 1 . . . 4.

1. From your computer, choose Start>Programs>TightVNC>TightVNC Viewer.
2. Click Options.

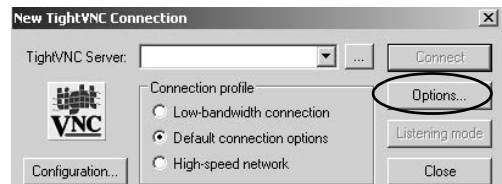

3. Clear View only (inputs ignored).

4. Click OK.

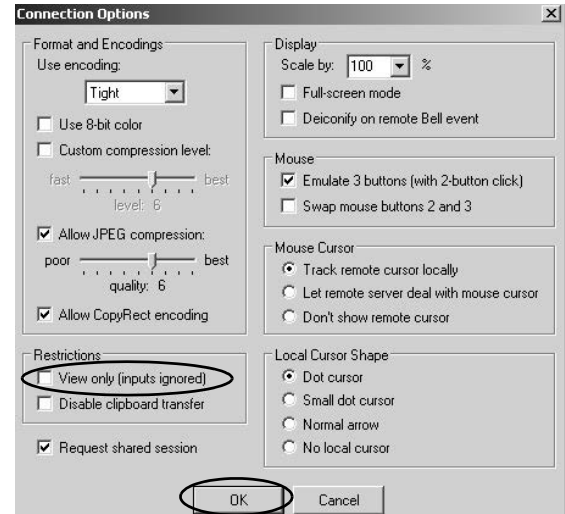

5. Enter the IP address of your terminal and click Connect.



Click the network connection icon in the system tray to view IP information.

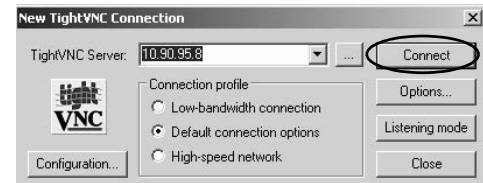

The Standard VNC Authentication dialog box opens.

6. Enter the control password that was defined in the VNC configuration dialog box on the terminal and click OK.

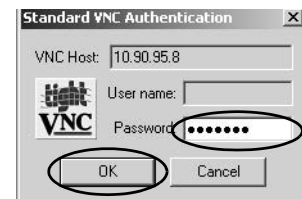

The PanelView VNC viewer opens.

7. On your computer, perform some actions to verify that you have control of the terminal.

8. When finished, close the PanelView VNC Server.

Web Server Configuration

The Web Server tab in the Network Server Configuration dialog box configures settings that are used for HTTP web activities. These are standard Microsoft Windows CE parameters.

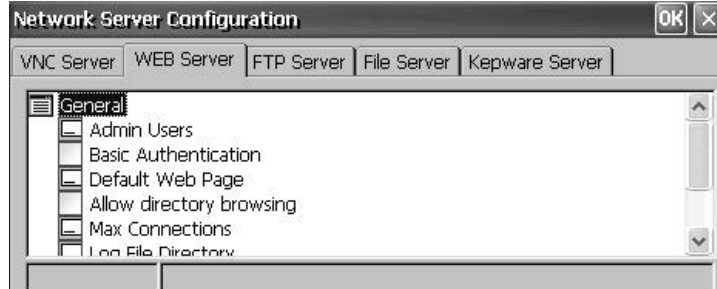

TIP Always click OK to apply new settings. You are asked if you want to restart the service immediately.

Table 29 - Web Server Parameters

| Parameter | Description | Default |
|--------------------------|--|-----------------------|
| Admin Users | Specifies a list of users allowed to administer web activities. When selected, you can enter a list of user names, separated by semicolons, in the field that opens at the bottom of the dialog box. | ADMIN |
| Basic Authentication | Check this option to require a user name and password to access the web server. | Disabled (unchecked) |
| Default Web Page | Specifies default web pages users can access. | default.htm;index.htm |
| Allow Directory Browsing | Check this option to let users browse directories on a web server. | Disabled (unchecked) |
| Max Connections | Specifies the maximum number of incoming web connections. | 256 |
| Log File Directory | Specifies the path where the log file is stored. This file logs web activity. | \windows\www |
| Max Log Size | Specifies the maximum size of the log file stored in the log file directory. A new log file is created, when the current log file reaches the maximum size. | 32768 bytes |
| NTLM Authentication | Check this option to require a valid user name and password to access the web server. If NTLM Authentication is enabled, you must enter a valid user name in the Admin Users field. NTLM user accounts are defined in the User Account Manager of the control panel. | Enabled (checked) |

FTP Server Configuration

The FTP Server tab in the Network Server Configuration dialog box configures settings that are used for exchanging files over a network. These are standard Microsoft Windows CE parameters.

The default FTP configuration lets any user establish an FTP connection to the HMI terminal by logging in anonymously and downloading files from the FTP default directory (\Temp).

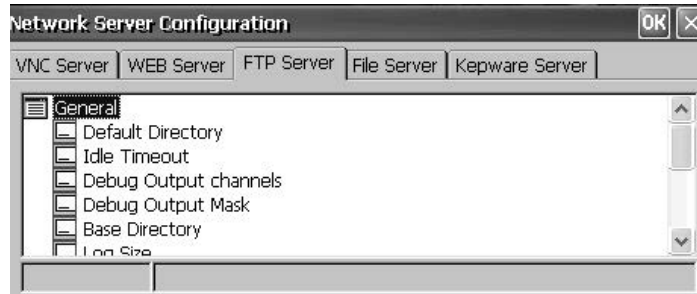

TIP Always click OK to apply new settings. You are asked if you want to restart the service immediately.

Table 30 - FTP Server Parameters

| FTP Parameters | Description | Default |
|----------------------------|---|-------------------------|
| General | | |
| Default Directory | Specifies a storage location on your HMI terminal for transferring files. This is the directory that users come to when they first connect to the FTP server. | \Temp\ |
| Idle Timeout | Specifies the time in seconds before the inactive control connections are closed during a data transfer. An FTP session requires one control connection, plus one data connection during file transfers. Without a timeout, the FTP server process can be left pending indefinitely if the corresponding client crashes without closing the control connection. | 300 seconds (5 minutes) |
| Debug Output Channels | Specifies the number of debug output channels. | 2 |
| Debug Output Mask | Specifies the port number of the output mask used for debugging. | 23 |
| Base Directory | Specifies the path where the FTP log file and other support files are stored. | \Windows |
| Log Size | Specifies the maximum size of the file that logs FTP activities. The log file is stored in the base directory. A new log file is created when the current log file is the maximum size. | 4096 bytes |
| Security Parameters | | |
| Use Authentication | Check this option to require a valid NTLM user name and password to access the FTP server. If authentication is enabled, you must enter one or more valid user names in the User List field. NTLM user accounts are defined in the User Account Manager of the control panel. | Enabled (checked) |
| Allow Anonymous Logins | Check this option to let anyone connect to the ftp server. Anonymous logins do not require a user name and password. | Enabled (checked) |
| Allow Anonymous Uploads | Check this option to let users logged in anonymously to upload (or write) files to the FTP server (or default directory). If unchecked, users logged in anonymously can download (or copy) files from the server. | Disabled (unchecked) |
| Allow Anonymous VRoots | Check this option to let users logged in anonymously access virtual roots. | Disabled (unchecked) |
| User List | Specifies the NTLM users that can access the ftp server and exchange files to or from the default directory. When selected, you can enter a list of NTLM user names, separated by semicolons, in the field that opens at the bottom of the dialog box. User names and passwords are defined in the User Account Manager of the control panel. | None |

FTP Anonymous Login and Upload

Follow these steps to establish an FTP connection to the terminal by allowing anonymous logins and file transfers to or from the default FTP folder on the terminal.

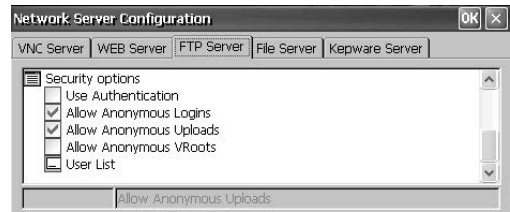

TIP If Allow Anonymous Uploads is not checked, you can copy files from the default FTP folder on the terminal but not to the folder.

1. Open your web browser or any folder on your computer.



TIP You need the IP address of your HMI terminal to establish an FTP connection. Click the network connection icon in the system tray to view IP information.

2. Type the IP address of the terminal in the address field by using the syntax ftp://ipaddress_of_hmi_terminal.

ftp://10.90.95.8

An anonymous connection is established to the \Temp folder (the FTP default directory on the terminal). The folder shows two files.

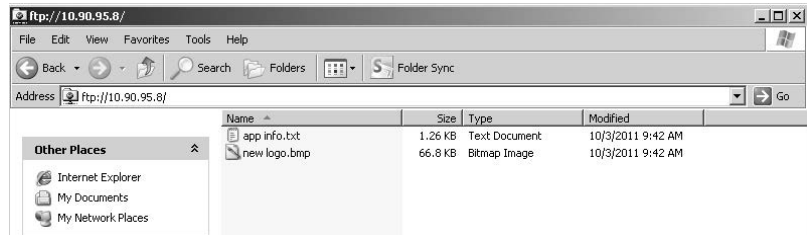

If you launch the FTP connection from your browser, this view appears.



To see the folder view, click Page, then from the File menu, choose Open FTP site in Windows Explorer.

3. Transfer files between your computer and the FTP folder:
 - Drag or copy a file from the FTP folder to your computer.
 - Drag or copy a file to the FTP folder from your computer.

FTP Connection Requiring User Authentication

Follow these steps to establish an FTP connection to the terminal by first entering a valid user name and password.

1. Open your web browser or any folder on your computer.
2. Type the IP address of the HMI terminal in the address field by using the syntax ftp://ipaddress_of_hmi_terminal.
ftp://10.90.95.8
3. Click OK when you see the FTP Folder Error dialog box.

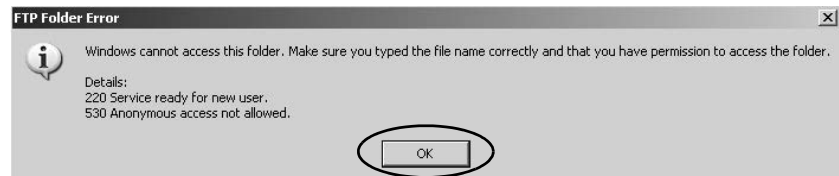
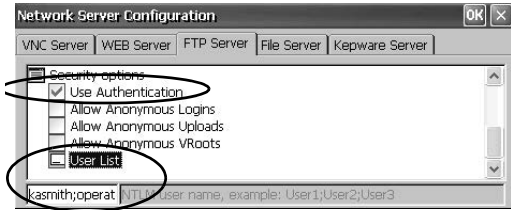

If you launch the FTP connection from your browser, a prompt can appear notifying you that Internet Explorer cannot display this web page. Choose Page>File>Open FTP site in Windows Explorer.

4. From the File menu, choose Login As.

The user name field is populated with the first user name entered in the User List of the FTP configuration.

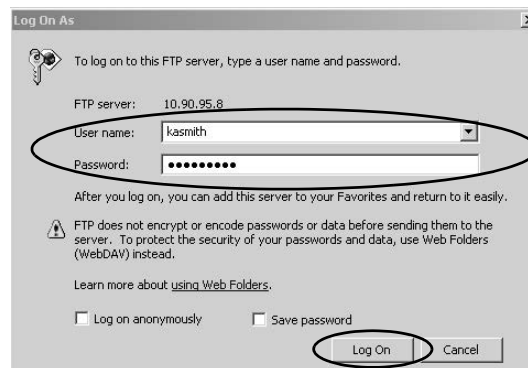

TIP The user name you enter must be in the User List of the FTP configuration and previously set up as a valid account in User Accounts of the control panel.

5. Type a valid user name and password, then click Log On.

The default FTP directory on the terminal opens. You can transfer files to or from this folder.

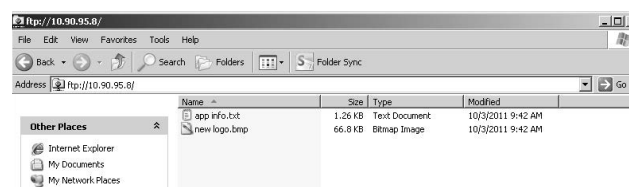

File Server Configuration

The File Server tab in the Network Server Configuration dialog box provides settings that provide shared access to files, printers, serial ports, and miscellaneous communication between computers on a network. These are standard Microsoft Windows CE parameters.

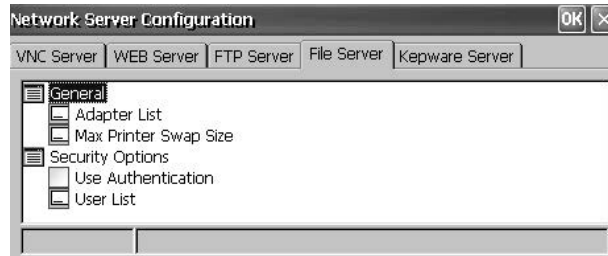

TIP Always click OK to apply new settings. You are asked if you want to restart the service immediately.

Table 31 - File Server Configuration

| Parameter | Description | Default |
|-----------------------|---|----------------------|
| General | | |
| Adapter List | Provides a list of valid adapters. | * (all adapters) |
| Max Printer Swap Size | Specifies the maximum size of the printer swap file. | 4096 bytes |
| Security Options | | |
| Use Authentication | Check this option to require a valid NTLM user name and password to access the file server. If authentication is enabled, you must enter one or more valid user names in the User List field. NTLM user accounts are defined in the User Account Manager of the control panel. | Disabled (unchecked) |
| User List | Specifies a list of valid NTLM users allowed to access the file server. When selected, you can enter a list of NTLM user names, separated by semicolons, in the field that opens at the bottom of the dialog box. User names and passwords are defined in the User Account Manager of the control panel. | None |

KEPServer Configuration

The KEPServer tab in Network Server Configuration lets you select Kepware communication drivers for a connected device.

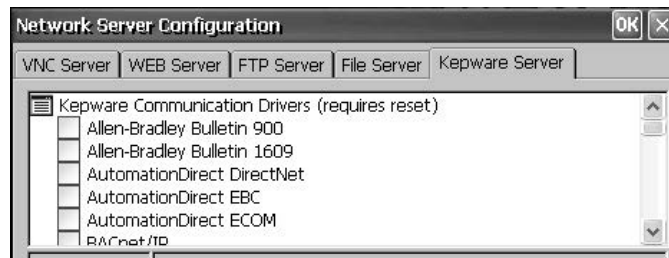

TIP Always click OK to apply new settings. You are asked if you want to restart the service immediately. You must also reset your terminal.

Printer Support

The terminals support selected USB printers such as Canon, Epson, Hewlett-Packard, and Brother. Automatic printer installation that uses plug-and-play capabilities is supported as well as manual installation if a suitable printer driver is available. You can connect a printer to the USB host port on the terminal.

For more information on supported printers, go to the knowledgebase at <http://www.rockwellautomation.com/support/> and search for ID 111636 in the Search Answers box.

Printers are configured and managed from Printers in the control panel on the terminal desktop. A wizard is supported for each printer type.

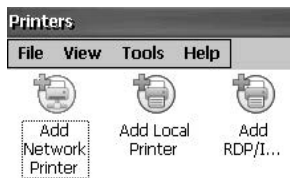

Table 32 - Support for Printers

| Printer Type | Description |
|--------------|--|
| Local USB | You can connect a JETCET supported printer to a USB host port. The printer attached to the USB host port can be shared by a remote terminal when configured as a network printer on the remote terminal. |
| Network | The terminal supports a remote printer connected to the network via the Ethernet port. The printer can be addressed by its device name or IP address. |
| RDP /ICA | A local printer can be made available to a Windows server application that is running in an RDP (Remote Desktop Protocol) session on the terminal. ⁽¹⁾ |

(1) Applies only to PanelView Plus 6 terminals with extended features.

After configuring a printer, you can access it from desktop applications or from FactoryTalk View ME Station Configuration mode by pressing Terminal Settings>Print Setup. Applications can also select and share printers.

Automatic Printer Installation

Follow these steps to install a plug-and-play printer from the Windows desktop. For manual printer installation, refer to [page 103](#).

TIP The procedure illustrates automatic plug-and-play installation for the Hewlett Packard HP deskjet 5650 printer.

1. Connect the printer to the USB host port on the terminal.
2. Plug the power cord of the printer into an outlet and turn the printer on.

Windows detects your plug-and-play printer and, in many cases, installs it without requiring you to make any selections.

The printer is ready to print.

IMPORTANT If automatic plug-and-play installation is not supported for a printer, this error is logged to the System Event log in the Hardware Monitor. 'JETCET PRINT was unable to auto-configure printer. To manually configure printer, go to the Printers folder from the Control Panel.'

3. Verify printer installation from the desktop control panel by opening Printers.

Notice the icon for the Deskjet 5650C printer. The check mark indicates this is the default printer.

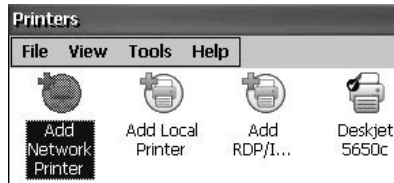

4. From the File menu, choose Properties to view the properties of the printer.

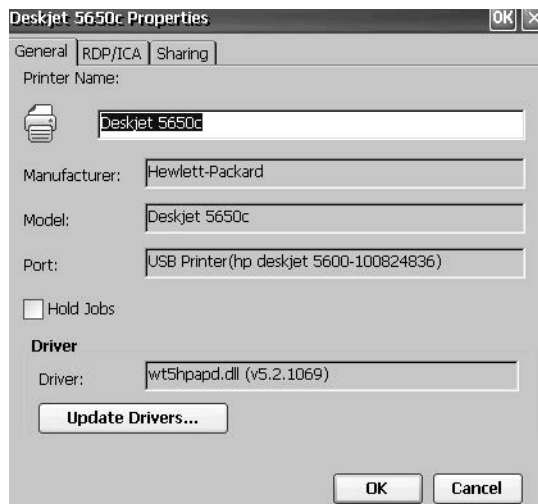

Printer configuration includes the printer name, manufacturer and model, printer driver, and port-specific parameters.

- TIP**
- New printer configurations are retained through a power cycle.
 - Printers set up through the desktop control panel are also available within FactoryTalk View ME Station Configuration mode by pressing Terminal Settings>Print Setup.

5. Right-click the printer and print a test page to verify installation.

When printing from an application such as WordPad, a Print dialog box opens where you can adjust print settings as needed.

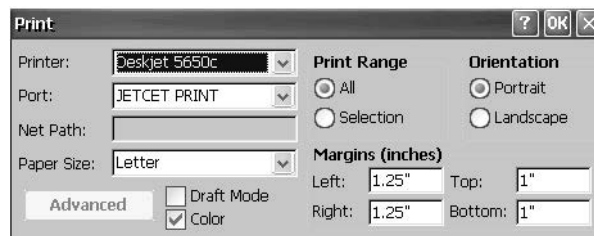

Manual Printer Installation

Follow these steps to manually set up a supported printer.

1. Connect the printer to the USB port.
2. Plug the power cord of the printer into an outlet and turn the printer on.
3. From the desktop control panel, open Printers.
4. Click Add Local Printer.



5. Follow the Add Local Printer Wizard instructions to configure the printer.
 - a. Verify the connected printer appears on the USB printer port.
 - b. Select the manufacture and model of the JETCET printer.
 - c. Accept the default printer name or enter another.
 - d. Print a test page to verify the installed printer.
 - e. Specify whether you want the printer to be shared on the network.

PDF Reader



A PDF reader is available on all PanelView Plus 6 terminals and provides typical PDF view and search functions. You can run this reader from the Windows desktop or from a command prompt.

When viewing a PDF document, you can initiate functions from the menu or toolbar. Bookmarks created in the original PDF appear under Bookmarks.

Figure 9 - PDF Reader Workspace

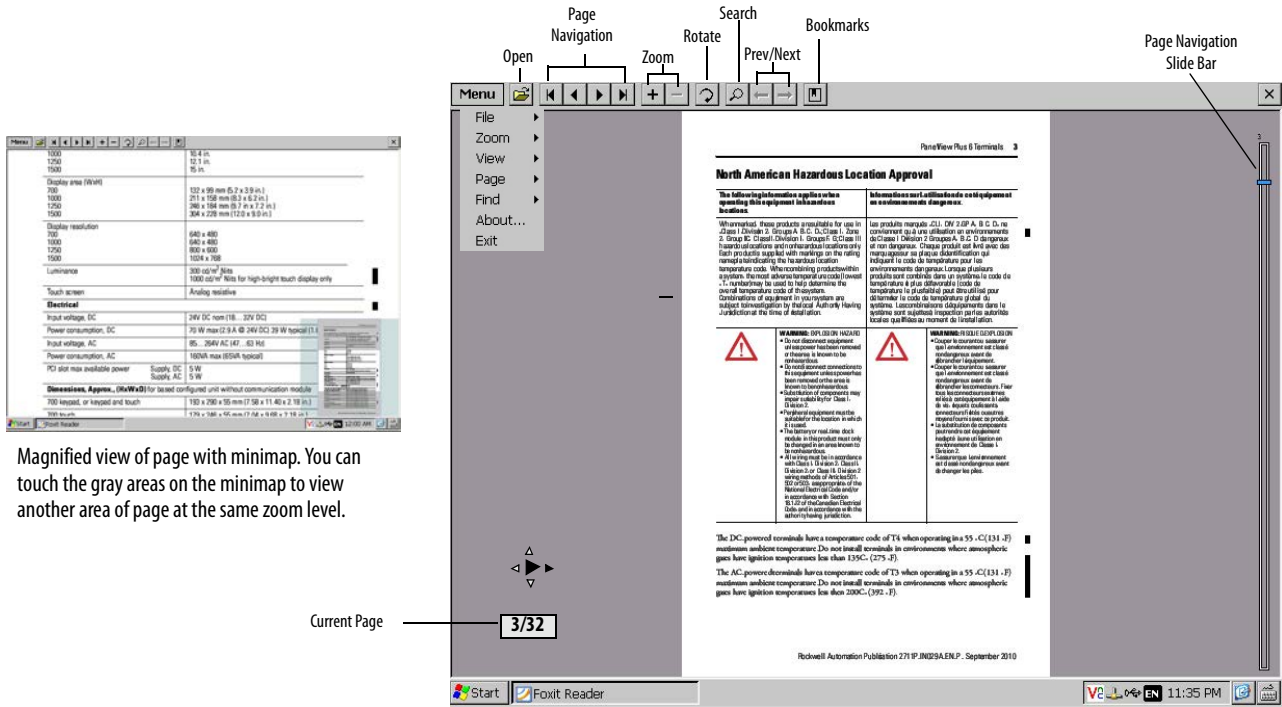

Magnified view of page with minimap. You can touch the gray areas on the minimap to view another area of page at the same zoom level.

TIP If a keyboard is attached, you can use the Page Up and Page Down keys for page navigation. On keypad terminals, hold down the Alt key while pressing the up and down cursor keys.

Some viewing functions can be initiated on touch-screen terminals by touching or dragging.

Table 33 - Touch Screen Operations

| To | Do This | Indicator |
|----------------|--|--|
| Zoom In or Out | Tap the screen once to zoom in. Tap the screen again to zoom out. If Menu>View>Minimap is chosen, a miniview of the page appears in lower right of workspace. You can tap the gray areas to change view. | |
| Navigate pages | <ul style="list-style-type: none"> Drag your stylus or finger to the right or left to view next and previous pages. An indicator shows the direction your are dragging. A box shows the current page/total page count. Drag up or down the screen to activate the page navigation bar on the right. Move slide bar up or down to navigate pages. | See page navigation bar in figure 8. |
| Rotate | Drag in a circular, clockwise or counterclockwise direction to rotate the page. | |

Command Prompt Parameters

You can run the PDF reader from the Windows Command Prompt by choosing Start>Programs>Command Prompt and executing the command parameters in [Table 34](#).

Command Prompt Syntax

Foxitreader "file_path/file-name.pdf" *parameter parameter_value*

- Enclose the file path and file name in double quotes and use forward slashes to separate the file path directories and file name.
- Use spaces to separate the parameter from the file name and optional parameter value.

Command Prompt Example

Foxitreader "windows/desktop/example.pdf" -p 4

This command prompt opens example.pdf in Foxit Reader at page 4.

Table 34 - Command Prompt Parameters

| Parameter | Parameter Function | Example | Description |
|---------------------|---|--|--|
| -p | Go to page | Foxitreader "file_path/file.pdf" -p 2 | Opens the PDF file to page 2. |
| -zw | Fit width | Foxitreader "file_path/file.pdf" -zw | Opens the PDF file and fits the view to the page width. |
| -zp | Fit page | Foxitreader "file.pdf"-zp | Opens the PDF file and shows the full page. |
| -z | Zoom to | Foxitreader "file.pdf"-z 150 | Opens the PDF file and zooms to 150%. |
| Multiple parameters | Enter empty spaces between parameters and parameter values | Foxitreader "file_path/file.pdf" -p 2 -zw | Opens the PDF file to page 2 and fits the view the page width |
| -b | Go to bookmark | Foxitreader "file_path/file.pdf" -b "Bookmark1" | Opens the PDF file to the location specified within Bookmark1 |
| -d | Go to named destination | Foxitreader "file_path/file.pdf" -b "Destination1" | Opens the PDF file to the location specified within Destination 1. |
| -g | Disable the File>Open command on the Menu and the Open folder button. | Foxitreader "file_path/file.pdf" -g | Opens the PDF file and dims the Menu, File>Open command the Open button. |

Notes:

Install and Replace Components

| Topic | Page |
|---|------|
| Install or Replace the Logic Module | 108 |
| Install or Replace a Communication Module | 109 |
| Replace the Display Module | 111 |
| Replace the Bezel | 112 |
| Replace the Backlight | 114 |
| Replace the Battery | 117 |
| Install the AC Power Supply Module | 119 |
| Remove the Product ID Label | 122 |
| Load an SD Card | 122 |
| Clean the Display | 123 |



ATTENTION: Prevent Electrostatic Discharge

This equipment is sensitive to electrostatic discharge, which can cause internal damage and affect normal operation.

Follow these guidelines when you handle this equipment:

- Touch a grounded object to discharge potential static.
- Wear an approved grounding wriststrap.
- Do not touch connectors or pins on component boards.
- Do not touch circuit components inside the equipment.
- Use a static-safe workstation, if available.
- Store the equipment in appropriate static-safe packaging when not in use.



SHOCK HAZARD: Disconnect power from the terminal before installing or replacing any components. Failure to disconnect power can result in electrical shock or damage to the terminal.

Required Tools

You need a #1 and #2 Phillips screwdriver to replace some of the components.

Install or Replace the Logic Module

The display modules and logic modules for the 1000 terminals can be ordered as separate components for field installation. If modules are ordered as separate components, attach the logic module to the display module before panel installation.

1. Disconnect power from the terminal.
2. Set the display module display-side down on a clean, flat, stable surface.
3. Position the logic module over the back of the display module, aligning the logic module connector with the connectors on the display module.

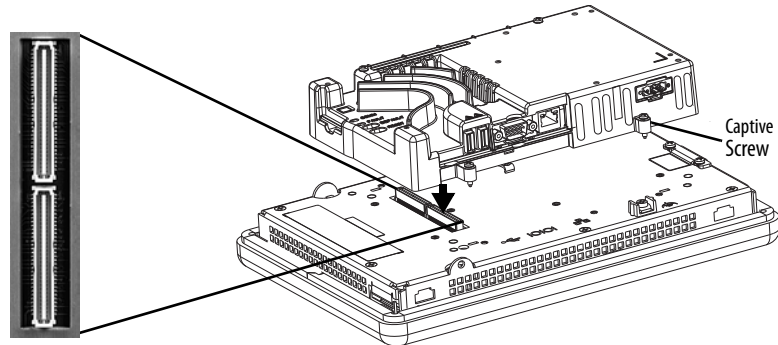

4. Push down on the logic module until it is firmly seated.
5. Tighten the four captive screws that secure the logic module to the display module and torque to 0.58 N•m (5...7 lb•in).

Before replacing a logic module, you must first remove the communication module, if attached.

Follow these steps to replace a logic module.

1. Disconnect power from the terminal.
2. Disconnect all power and communication cables.



WARNING: Do not connect or disconnect any communication cable with power applied to this device or any device on a network. An electrical arc could cause an explosion in hazardous location installations. Be sure power is removed or the area is known to be nonhazardous before proceeding.

3. Set the display module display-side down on a clean, flat, stable surface.

4. If the communication module is attached, remove the four screws that secure the communication module to the logic module and set the communication module aside.

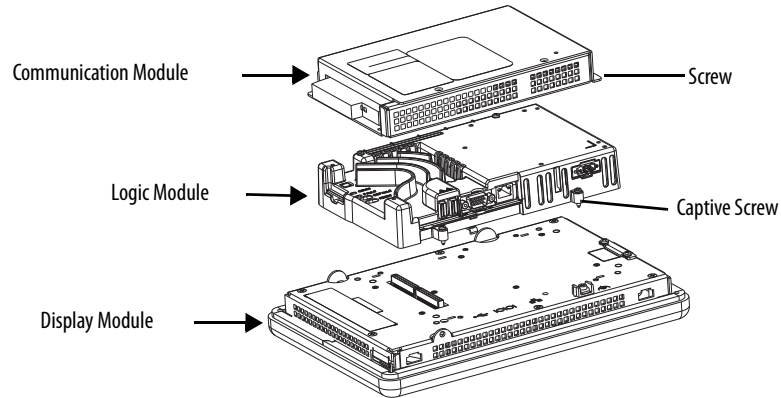

5. Loosen the four captive screws that secure the logic module to the display module.
6. Carefully lift the logic module from the back of the display.



ATTENTION: Wear a properly grounded ESD wristband before touching any of the electronic components in the logic module.

7. Install the new logic module and torque the four captive screws to 0.58 N•m (5...7 lb•in).
8. If necessary, install the communication module and torque the four screws to 0.58 N•m (5...7 lb•in).

Install or Replace a Communication Module

The communication module installs over the logic module. Communication modules for the 1000 terminals are available as separate catalog numbers for field installation.

TIP The logic module must be attached to the display module before you attach the communication module.

Follow these steps to install a communication module.

1. Disconnect power from the terminal.

2. If the display module is removed from the panel, set the terminal, display-side down, on a clean, flat, stable surface.

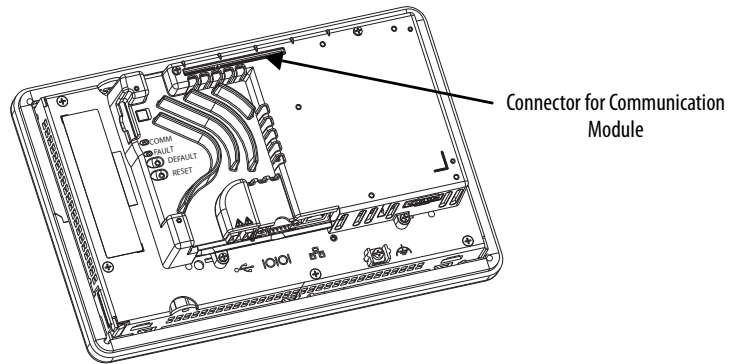

3. Position the communication module over the logic module so that the connector on the bottom of the module aligns with the connector on the logic module.
4. To prevent ESD between the modules, let the communication module touch the logic module before making the connection.

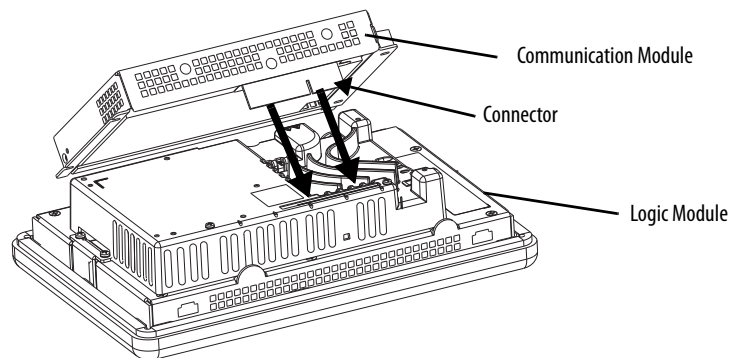

5. Push down on the communication module until the connectors are seated.
6. Tighten the four screws that secure the communication module to the logic module to a torque of 0.58 N•m (5...7 lb•in).

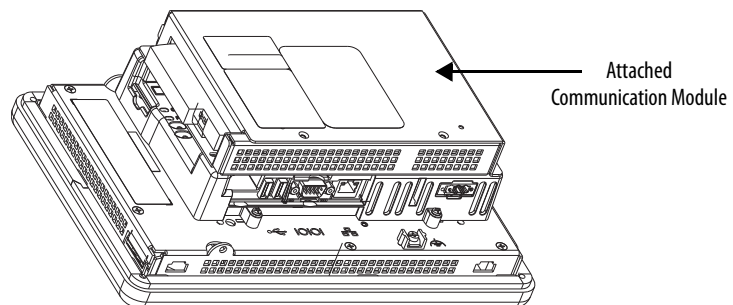

Follow these steps to replace a communication module.

1. Disconnect power from the terminal.
2. Disconnect communication cables from the module.



WARNING: Do not connect or disconnect any communication cable with power applied to this device or any device on a network. An electrical arc could cause an explosion in hazardous location installations. Be sure power is removed or the area is known to be nonhazardous before proceeding.

3. Remove the four screws that secure the communication module.
4. Carefully lift the communication module away from the logic module.
5. Install the new communication module by following steps 4..6 in [Install or Replace a Communication Module on page 109](#).

Replace the Display Module

Follow these steps to replace a 1000 display module.

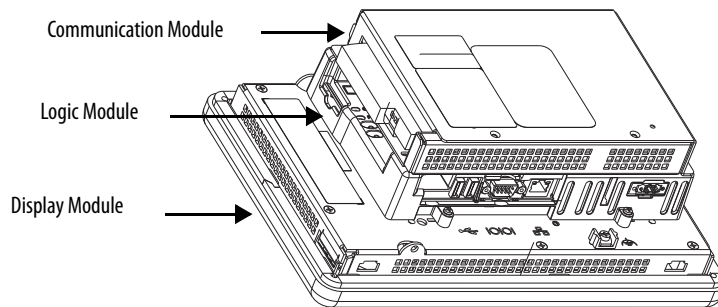

Follow these steps to replace the display module.

1. Disconnect power from the terminal.
2. Remove the terminal from the panel.
3. If the communication module is attached, remove the four screws that secure the communication module to the logic module.
4. Loosen the four captive screws that attach the logic module to the display module.
5. Carefully lift the logic module from the display module.
6. Set the display module aside.

7. Position the logic module over the new display module so that the connectors align.

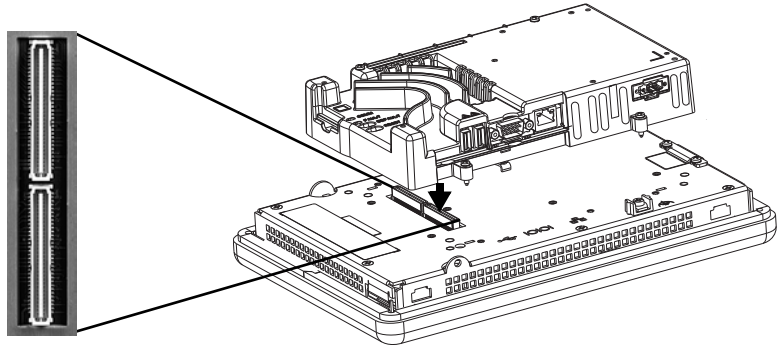

8. Push down on the logic module until firmly seated.
9. Tighten the four captive secures that secure the logic module to the display module and torque to 0.58 N•m (5...7 lb•in).
10. If necessary, attach the communication module and torque the four screws to 0.58 N•m (5...7 lb•in).

Replace the Bezel

You can replace the bezel on the 1000 terminals. It is not necessary to remove the logic module or communication module before removing the bezel, except on the 700 terminal.

Remove the Display Module Bezel

Follow these steps to remove the display module bezel.

1. Disconnect power from the terminal.
2. Set the terminal, display side down, on a flat stable surface.



ATTENTION: Wear a properly grounded ESD wristband before touching any of the electronic components in the logic module.

3. On touch-screen only terminals, remove the two screws that secure the small metal plate to the back of the display module.

4. Disconnect the touch screen connector.

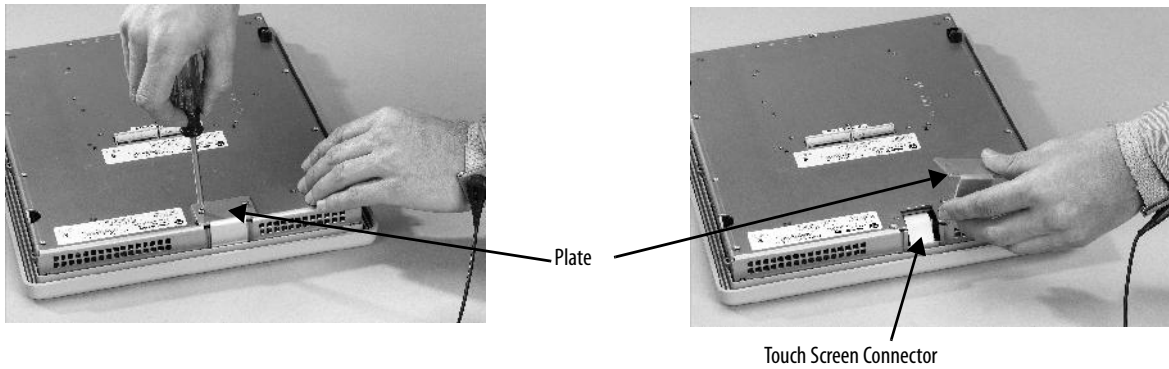

5. Remove the screws from the back of the display module.

The number of screws varies for each terminal type.

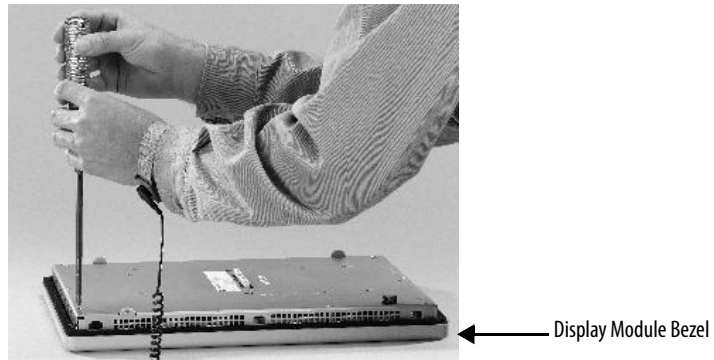

6. Remove the sealing gasket.



7. Lift the back of the display module away from the bezel.

Work on a clean, flat, stable surface to protect the display from debris, scratches, and damage.

8. Detach the connectors:

- Function key connector
- Connector on keypad or keypad/touch units

9. Set the bezel aside.

Replace the Display Module Bezel

Follow these steps to replace the display module bezel.

1. Make sure the bezel is free of lint and marks before attaching.
2. Attach the connectors:
 - Function key connector
 - Connector on keypad or keypad/touch units
3. Place the back of the display module over the bezel.

Be careful not to pinch any of the cables. Let the touch screen connector out of the access opening.
4. Attach the touch screen connector.
5. Replace the new sealing gasket.
6. Attach the screws that secure the display module to the bezel and tighten to a torque of 1.35...1.58 N•m (12...14 lb•in).
7. On touch-screen terminals, reattach the small metal plate to the back of the display module and torque the two screws to 0.58 N•m (5...7 lb•in).

Replace the Backlight

The 1000 CCFL-display modules have replaceable backlights. Backlight replacement does not apply to LED displays.

Table 35 - CCFL Backlight Replacements⁽¹⁾

| Use Cat. No. | For Display | Series | Number of CCFL Backlights |
|--------------|-------------|---------|---------------------------|
| 2711P-RL10C | 1000 | A | 1 |
| 2711P-RL10C2 | | B and C | 1 |

(1) These CCFL-backlight replacement catalog numbers do not apply to LED displays.

IMPORTANT Disposal: The backlights for these products contain mercury. Dispose of per applicable laws.

Follow these steps to replace the backlight.

1. Disconnect power from the terminal.
2. Remove the display module bezel.
3. Remove the four screws that secure the LCD display.

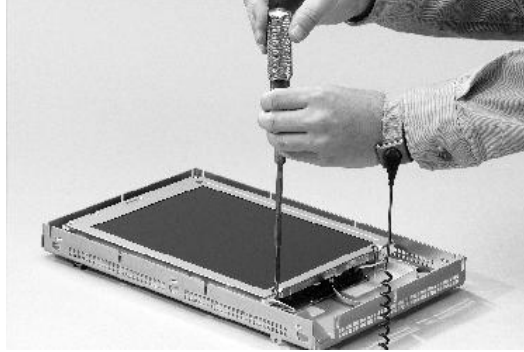

4. Lift the LCD display and detach the display connector from the circuit board.

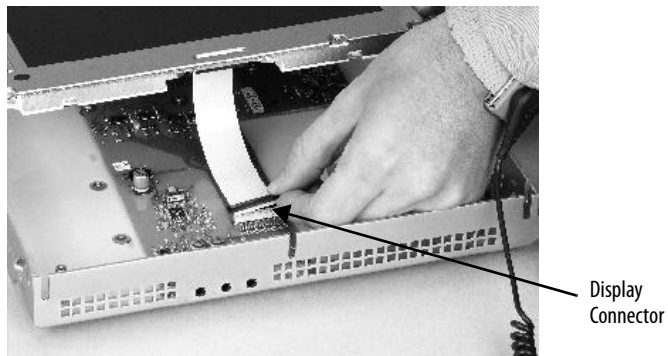

5. Detach the backlight connectors from the circuit board.
6. Press the retaining tab that secures the backlight, then pull out the backlight.

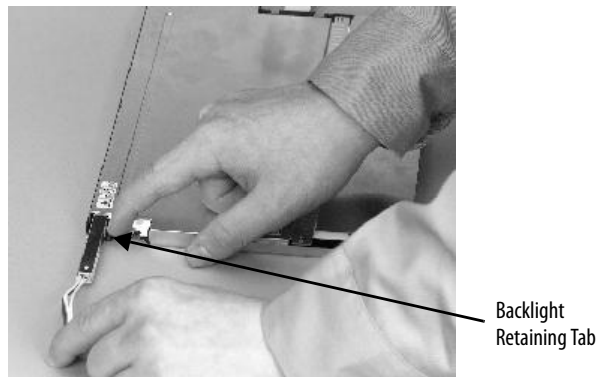

7. Insert the new backlight.

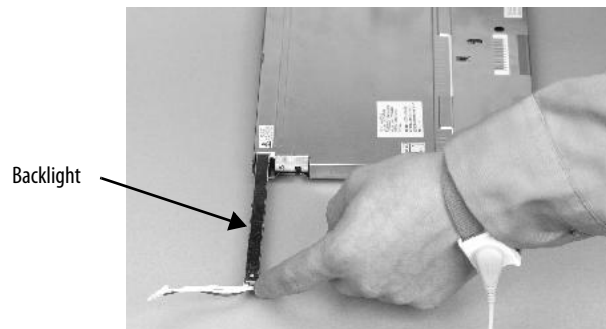

8. Insert the new backlights then secure each with the same screws from the previous step, and torque to $0.117 \text{ N}\cdot\text{m}$ ($1.04 \text{ lb}\cdot\text{in}$).
9. Attach the LCD display connector to the circuit board.
Refer to [step 4](#).
10. Attach the backlight connector to the circuit board.
Refer to [step 5](#).
11. Secure the LCD display with the four screws.
Tighten the screws and torque to $0.58 \text{ N}\cdot\text{m}$ ($5\text{...}7 \text{ lb}\cdot\text{in}$).
12. Replace the display module bezel.

Replace the Battery

The product has a lithium battery that is used by the real-time clock. It is not used for backup or retention.



This product contains a sealed lithium battery which may need to be replaced during the life of the product.

At the end of its life, the battery contained in this product should be collected separately from any unsorted municipal waste.

The collection and recycling of batteries helps protect the environment and contributes to the conservation of natural resources as valuable materials are recovered.



SHOCK HAZARD: Failure to follow proper safety precautions could result in severe electrical shock or damage to the terminal.



WARNING: There is a danger of explosion if the lithium battery or real-time clock module in this product is incorrectly replaced. Do not replace the battery or real-time clock module unless power has been removed and the area is known to be nonhazardous.

Replace the battery with catalog number 2711P-RY2032 or an equivalent CR2032 coin cell battery.

Do not dispose of the lithium battery or real-time clock module in a fire or incinerator. Dispose of used batteries in accordance with local regulations.

For safety information on the handling of lithium batteries, including handling and disposal of leaking batteries, see Guidelines for Handling Lithium Batteries, publication [AG 5-4](#).

400 and 600 Terminals

You can replace the battery with the terminal mounted in the panel. No special tools are required to remove the battery.

Follow these steps to replace the battery in a 400 or 600 terminal.

1. Disconnect power from the terminal.
2. Unlatch the battery cover by pulling it straight out.

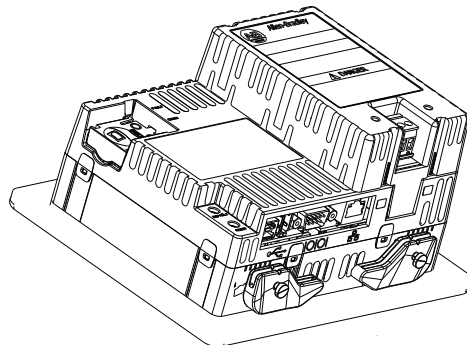

3. Lift up on the cover.
4. Remove the battery.

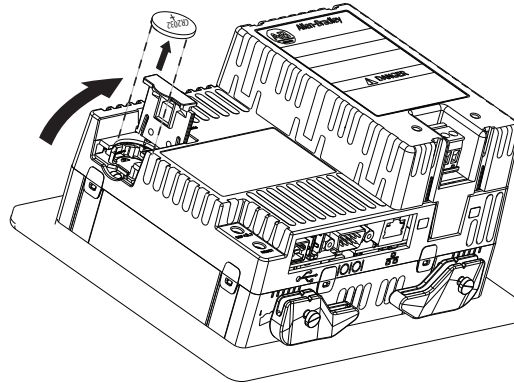

5. Insert the new battery with the positive (+) polarity facing up and press gently until the battery snaps into place.

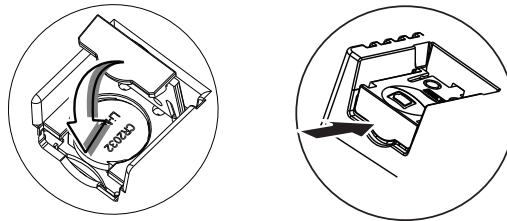

6. Close the battery cover and push the end in until you hear a click.

1000 Terminals

Follow these steps to replace the battery.

1. Disconnect power from the terminal.
2. Place the terminal, display side down, on a flat stable surface.
3. If the communication module is attached, remove the four screws that secure the communication module to the logic module.
4. Loosen the four captive screws that attach the logic module to the display.

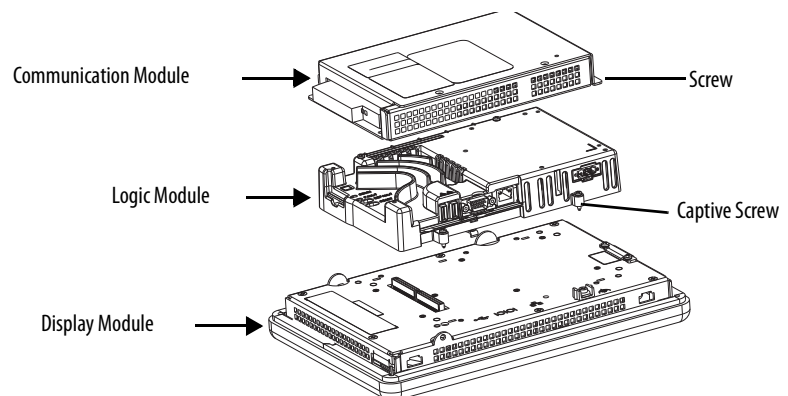

5. Carefully lift the logic module away from the terminal and turn over to expose the circuit board.
6. Locate the battery on the circuit board.
7. Remove the battery by lifting up the side of the battery.
The battery can be removed up to 15 seconds without losing clock and calendar data.
8. Insert the new battery.
9. Reattach the logic module by aligning the two connectors on the bottom of the logic module with the connectors on the back of the display module.

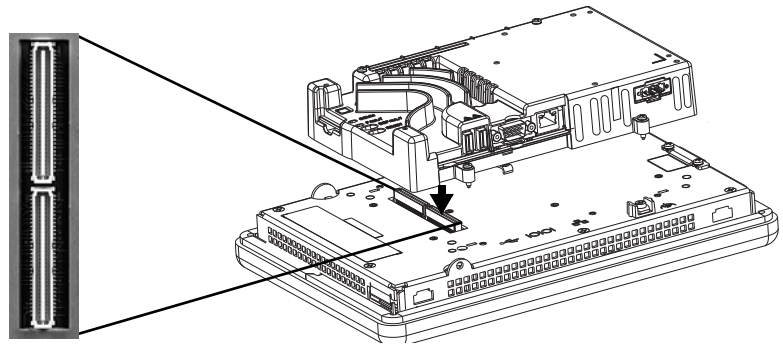

10. Push down on the logic module until it is firmly seated.
11. Tighten the four captive screws that secure the logic module to a torque of 0.58 N•m (5...7 lb•in).
12. If necessary, reattach the communication module and torque the four screws to 0.58 N•m (5...7 lb•in).

Install the AC Power Supply Module

The AC power supply module, catalog number 2711P-6RSA, attaches to the back of a DC-powered terminal to convert the terminal from DC to AC power.

Table 36 - AC Power Supply Ratings

| Input Voltage | Power Consumption |
|----------------------------|-------------------|
| 100...240V AC (50...60 Hz) | 35VA max |

You can install the AC module with the terminal mounted in the panel. No special tools are needed.

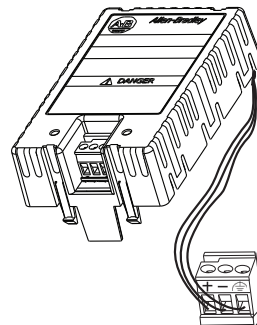

Follow these steps to attach and wire the AC power module.

1. Disconnect power to the terminal.
2. Remove the DC power terminal block currently installed in your terminal.

See [Remove and Install the Power Terminal Block on page 26](#).

3. Plug the DC power terminal block connected to the AC power supply module into the terminal.

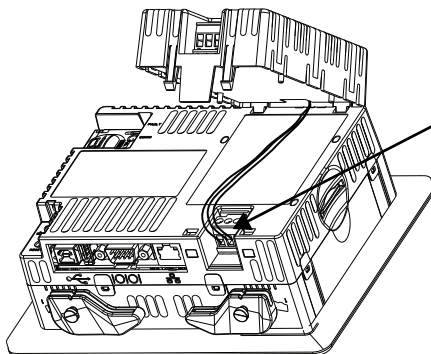

4. Insert the two short tabs on the AC module into the slots on the back of the terminal.

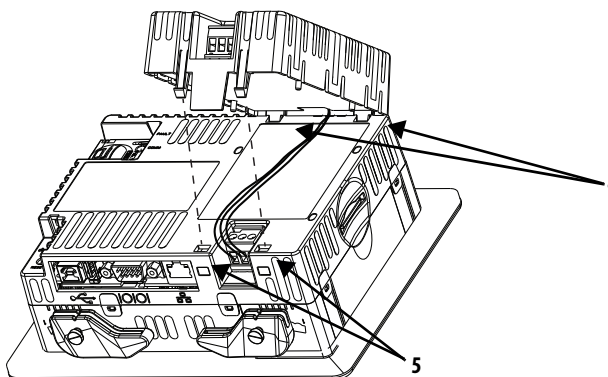

5. Push down on the module until the two long tabs snap into the slots on the opposite side of the terminal.

Make sure the module is securely connected and that the power supply wires are not pinched between the module and the terminal.

Follow these steps to connect the AC power to the terminal block module on the AC module.

1. Secure the AC power wires to the marked terminals (L1 and L2N) on the power terminal block.

Table 37 - Wire Specifications for Power Terminal Block

| Wire Type | Dual-wire Size ⁽¹⁾ | Single-wire Size | Strip Length | Screw Torque |
|--|--|--|-----------------|----------------------------------|
| Stranded or solid Cu 90 °C (194 °F) | 0.3...1.3 mm ² 22...16 AWG | 0.3...2.1 mm ² (22...14 AWG) | 7 mm (0.28 in.) | 0.45...0.56 N•m (4...5 lb•in) |

(1) Two-wire max per terminal.

- Secure the protective earth/ground wire to the marked position on the power terminal block.



ATTENTION: You must connect the protective earth terminal to a low impedance earth ground. The protective earth connection to ground is mandatory and required for both safety and regulatory compliance.

Table 38 - Protective Earth Wire Specifications

| Symbol | Wire Type | Wire Gauge | Terminal Screw Torque |
|--------|-------------------|---|----------------------------------|
| | Stranded or solid | Cu 90 °C (194 °F) 2.1...3.3 mm ² (14...12 AWG) | 0.45...0.56 N·m (4...5 lb·in) |

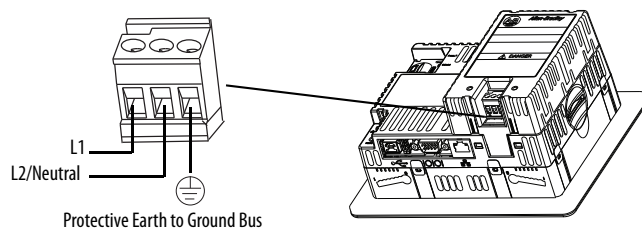

ATTENTION: Improper wiring of the power terminals can result in voltage at the communication connector shells.

Do not apply power to the terminal until all wiring is connected. Failure to do so can result in electrical shock.

- Apply power to the terminal.

Follow these steps to remove the AC power module.

- Disconnect power to the terminal.
- Remove the power wiring from the AC power terminal block.
- Insert a small, flat-blade screwdriver into one of the two slots below the AC module and pry up to release the tabs from the slot.
- Pull up on the front of the module to release the back tabs.
- Remove the DC power terminal block and wiring from the terminal.

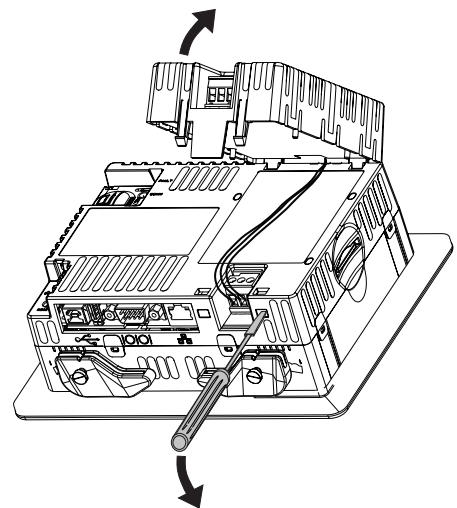

Remove the Product ID Label

You can replace the product ID label on the terminal with a custom label.

1. Remove the Allen-Bradley label by using your fingers or a tweezers.



2. Clean area with damp cloth and isopropyl alcohol.
3. Remove adhesive backing of new label and affix to the same location.

Load an SD Card

A Secure Digital (SD) card provides extra storage when inserted into the SD card slot. Supported cards include catalog number 1784-SDx. The SD cards are hot-swappable; they can be inserted and removed while the terminal is operating.

The SD card slot is accessible from the inside or back of the panel in which the terminal is installed.

Follow these steps to install an SD card in the card slot.

1. Verify that the SD card is locked or unlocked according to your preference:
 - If unlocked, the terminal can write data to or read data from the card.
 - If locked, the terminal can only read data from the card.

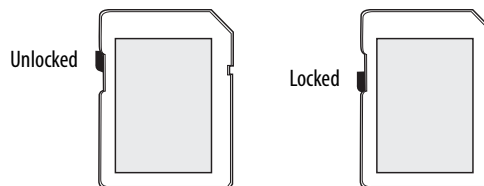

ATTENTION: Orient the SD card correctly before inserting into slot. Forcing the card into the slot can damage the card or the terminal.

2. Insert the SD card firmly into the slot until you hear a click.

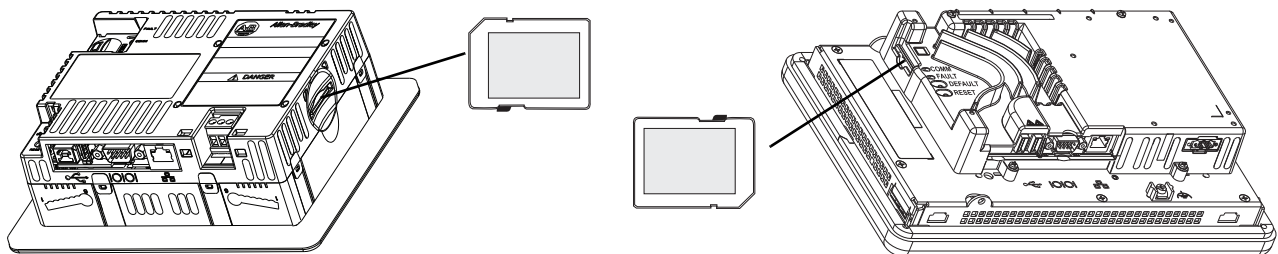

Press and release the SD card to eject the card from the slot.

TIP

- SD card volumes are named StorageCard2, StorageCard3,...
- SD card volumes and their physical characteristics are consistent with the CompactFlash card used by other PanelView Plus products. You can migrate applications on CompactFlash cards to an SD card.

Clean the Display

Use a protection antiglare overlay for easier cleaning of the display screen.



ATTENTION: Abrasive cleaners or solvents can damage the display. Do not scrub or use brushes on the display.

Follow these steps to clean the display screen.

1. Disconnect power from the terminal.
2. Use a clean sponge or soft cloth with mild soap or detergent to clean the display.
3. Dry the display with a chamois or moist cellulose sponge to avoid water spots.

Remove fresh paint splashes and grease before drying by rubbing lightly with isopropyl alcohol (70% concentration). Then wash the display by using mild soap or detergent. Rinse with clean water.

Notes:

Connections and Communication

| Topic | Page |
|------------------------|------|
| USB Ports | 126 |
| Ethernet Connection | 127 |
| Serial Connection | 129 |
| Controller Connections | 132 |



ATTENTION: Wiring and Safety Guidelines

Use publication NFPA 70E, Electrical Safety Requirements for Employee Workplaces, IEC 60364 Electrical Installations in Buildings, or other applicable wiring safety requirements for the country of installation when wiring the devices. In addition to the NFPA guidelines, here are some other guidelines to follow:

- Route communication cables to terminal by a separate path from incoming power. Do not run signal wiring and power wiring in the same conduit.
- Cross power and communication lines at right angles if they must cross.
- Communication lines can be installed in the same conduit as low-level DC I/O lines (less than 10V).
- Shield and ground cables appropriately to avoid electromagnetic interference (EMI). Grounding minimizes noise from EMI and is a safety measure in electrical installations.

For more information on grounding recommendations, refer to the National Electrical Code published by the National Fire Protection Association.

USB Ports

All terminals have one USB 2.0 host port, and the 400 and 600 terminals have one USB 2.0 device port.

Figure 10 - USB Ports

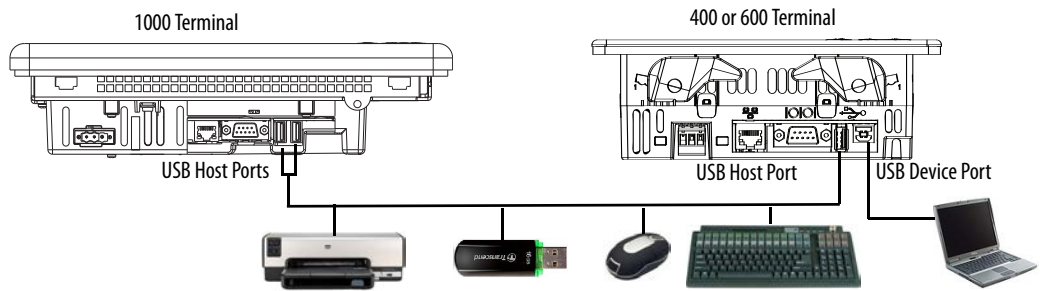

IMPORTANT The USB host and device ports are intended only for temporary use and must not be used for runtime operations.

Table 39 - USB Device Support

| USB Port Type | Supported USB Devices | Tips |
|--|---|---|
| Host Ports (type A) | <ul style="list-style-type: none"> Keyboard or mouse, HID devices with native device drivers USB drives for external storage Supported printers Cameras, modems, and bar code readers | For list of compatible devices, go to: http://www.rockwellautomation.com/knowledgebase and search the Knowledgebase for ID 115072. USB drive volumes are named USB Storage, USB Storage2,... USB drive partitions are managed by Storage Manager in the Control Panel. |
| Device Port (type B, only 400 and 600 terminals) | Host computer with the USB remote RNDIS network device driver installed. | For details on how to install the USB remote NDIS driver on your computer and configure the terminal for the USB connection, go to http://www.rockwellautomation.com/knowledgebase and search the Knowledgebase for ID 115608. |

IMPORTANT Refer to [page 19](#) for information on using the USB host ports and USB peripheral devices in hazardous locations.

The USB ports are identified by a USB icon. Each USB host port supports 0.5 A at 5V DC. Connected USB devices must not exceed this power load.

Table 40 - USB Connector Pinouts

| USB Icon | USB Ports | Pin | Signal | Description |
|----------|-----------|-----|--------|-------------|
| | | 1 | VCC | +5V |
| | | 2 | D- | Data - |
| | | 3 | D+ | Data + |
| | | 4 | GND | Ground |

Use only hi-speed USB 2.0 certified cables for error-free transmissions.



WARNING: USB devices not powered by the USB port must be within the same enclosure as the terminal. USB devices must be connected to a ground system common with the terminal or used with a USB hub providing galvanic isolation.

Connect only externally-powered USB hubs to the terminal. Before attaching devices to a USB hub, make sure the power adapter is connected and powered on.

Ethernet Connection

The Ethernet port connects to a controller on an EtherNet/IP network by using standard Ethernet and network connections. The port also supports application transfers and printing.

TIP The 2711P-RN20 Ethernet communication module is available for the 1000 terminals if another Ethernet port is required. The module has its own unique IP address.

Ethernet Connector

The Ethernet port has an RJ45, 10/100Base-T connector for network communication and supports MDI/MDI-X connections.

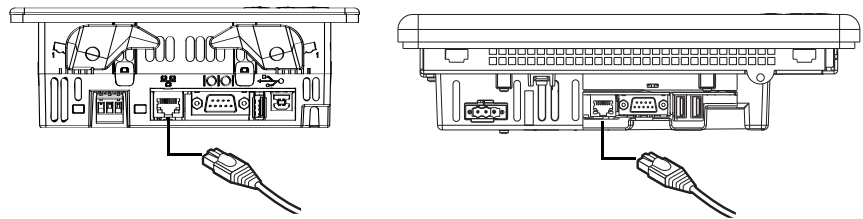

Table 41 - Ethernet Connector Pinout

| Connector | Pin | Pin Name | Pin | Pin Name |
|---|-----|------------|-----|-----------|
| RJ45 Connector  | 1 | Transmit + | 5 | Unused |
| | 2 | Transmit - | 6 | Receive - |
| | 3 | Receive + | 7 | Unused |
| | 4 | Unused | 8 | Unused |

Table 42 - Ethernet Status Indicators

| Indicator | Color | Description |
|----------------|--------|--|
| Link Integrity | Yellow | On when a link is present. |
| Activity | Green | Blinks when activity is detected on Ethernet link. |

Ethernet Cable

Table 43 - Ethernet Cable Requirements

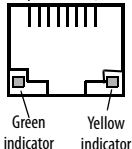
| For These Terminal Models | Use this Ethernet Cable |
|---------------------------|---|
| 1000 terminals | Belden 7921A shielded CAT5E cable according to TIA 568-B.1 and RJ45 connector according to IEC 60603-7 for compliance with Marine emission limits and the European Union 89/336/EEC EMC Directive. |
| 400 and 600 terminals | Use category five, twisted-pair cables. You can use a standard Ethernet cable or a crossover cable, such as catalog number 2711P-CBL-EX04, when connecting directly to a logic controller or switch. |

The maximum cable length between the Ethernet port and a 10/100Base-T port on an Ethernet hub (without repeaters or fiber) is 100 m (328 ft).



WARNING: Do not connect or disconnect any communication cable with power applied to this device or any device on the network. An electrical arc could cause an explosion in hazardous location installations. Be sure that power is removed or the area is nonhazardous before proceeding.

Security Considerations

IGMP (Internet Group Management Protocol) is used for IPv4 multicast. A multicast is communication between a single sender and multiple receivers on a network. IGMP is used to exchange membership status data between IPv4 routers that support multicasting and members of multicast groups. A router is an intermediary device on a communication network that expedites message delivery by finding the most efficient route for a message packet within a network, or by routing packets from one sub-network to another. A sub-network is a separate part of an organization's network identified through IP addressing.

PanelView Plus terminals provide level 2 (full) support for IPv4 multicasting (IGMP version 2) as described in RFC 1112 and RFC 2236.

SNMP (Simple Network Management Protocol) is used for internal network management and is not supported.

Ports 137 and 138 are normally open to support the NetBIOS protocol used by Windows CE.NET similar to other Microsoft and IBM network operating systems.

Serial Connection

The RS-232 serial port is multi-purpose and supports these connections:

- DH-485 communication through a serial connection
- DF1 full-duplex communication with controllers using direct connections or modem connections
- Third-party point-to-point communication
- Application transfers and printing

The serial port is a 9-pin, male, RS-232 connector. [Table 44](#) shows the pinout descriptions and how these pins map to the serial ports on the controllers.

The maximum cable length for serial communication is 15.24 m (50 ft).

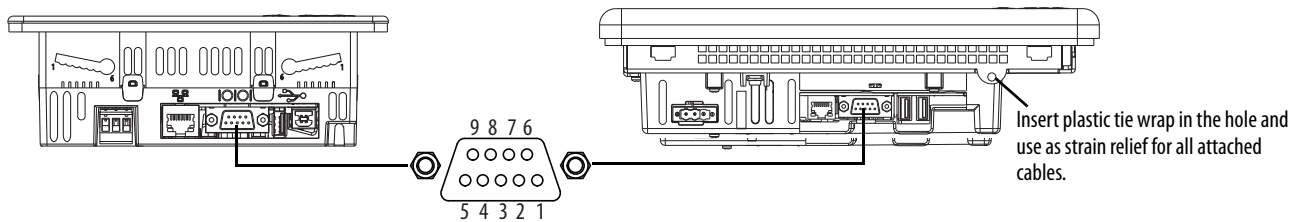

Table 44 - RS-232 Serial Port Connector Pinout

| PanelView Plus 6 Compact RS-232 Port 9-pin DCE | | SLC or Logix 9-pin | PLC 25-pin | MicroLogix/ ENI 8-pin DIN |
|---|-------------|-----------------------|---------------|------------------------------|
| 1 | | | | |
| 2 | RXD → | 2 | 3 | 4 |
| 3 | ← TXD | 3 | 2 | 7 |
| 4 | ← DTR | 4 | 20 | |
| 5 | ← COM → | 5 | 7 | 2 |
| 6 | → DSR | 6 | 6 | |
| 7 | ← RTS | 7 | 4 | |
| 8 | → CTS | 8 | 5 | |
| 9 | | | | |
| Connector Shell | Chassis Gnd | | | |



WARNING: Do not connect or disconnect communication cable with power applied to the terminal or the serial device connected to the terminal. An electrical arc could cause an explosion in hazardous location installations. Be sure that power is removed or the area is nonhazardous before proceeding.

Modem Connection

Wire or radio modem communication is possible between the terminal and controller. Each modem must support full duplex communication. Refer to your modem user manual for details on settings and configuration.

Figure 11 - Modem Connection

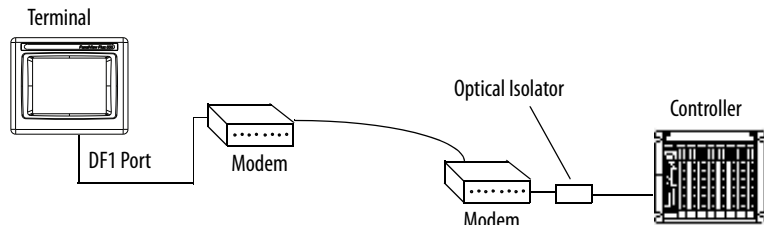

Construct a Null Modem Cable

To construct a null modem cable, refer to this pinout.

Table 45 - Null Modem Pinout

| Pin Description | PanelView Plus Compact 6 9-pin | 9-pin Modem | PanelView Plus Compact 6 9-pin | 25-pin Modem | Pin Symbol |
|---------------------------|--------------------------------|-------------|--------------------------------|--------------|------------|
| FG (Frame Ground) | - | - | - | 1 | FG |
| TD (Transmit Data) | 3 | 2 | 3 | 3 | RD |
| RD (Receive Data) | 2 | 3 | 2 | 2 | TD |
| RTS (Request to Send) | 7 | 8 | 7 | 5 | CTS |
| CTS (Clear to Send) | 8 | 7 | 8 | 4 | RTS |
| SG (Signal Ground) | 5 | 5 | 5 | 7 | SG |
| DSR (Data Set Ready) | 6 | 4 | 6 | 20 | DTR |
| DTR (Data Terminal Ready) | 4 | 6 | 4 | 6 | DSR |

Computer Connections

The RS-232 serial port supports application uploads and downloads between the terminal and a computer by using a direct connection.

Figure 12 - Serial Port Connection to Computer

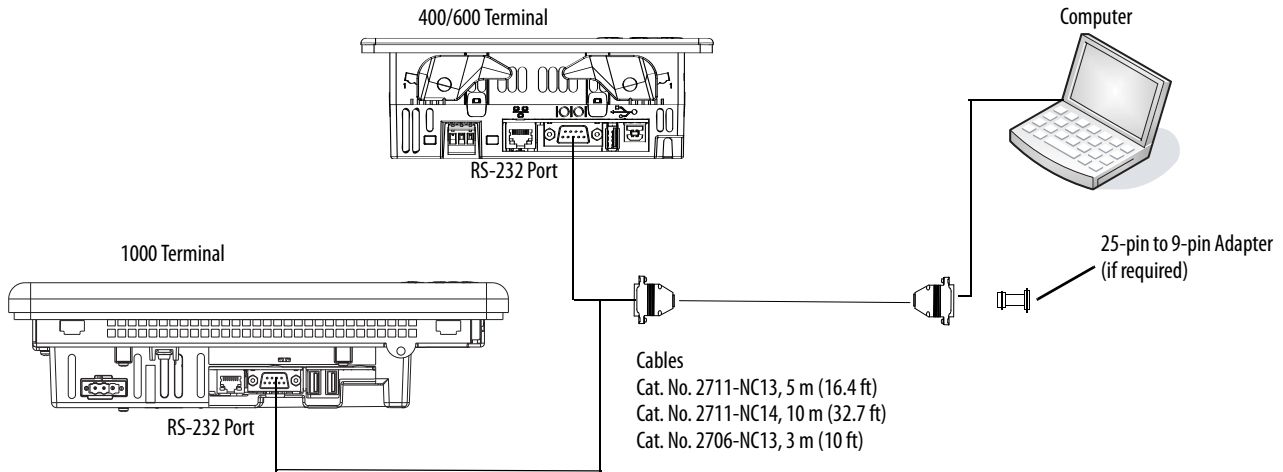

Table 46 - Upload/Download Cable with Handshaking

| PanelView Plus Port (DCE) | | Computer Port (DTE) with Handshaking | |
|---------------------------|-------|--------------------------------------|---------------------|
| 9-pin Male | | 9-pin Male | |
| 1 NC | | 1 | DCD |
| 2 | → RXD | 2 | RXD (Data Receive) |
| 3 | ← TXD | 3 | TXD (Data Transmit) |
| 4 NC | | 4 | |
| 5 | ↔ COM | 5 | COM |
| 6 (pulled high to +12V) | → DSR | 6 | DSR |
| 7 | ← RTS | 7 | RTS |
| 8 | → CTS | 8 | CTS |
| 9 NC | | 9 | NC |

Table 47 - Upload/Download Cable without Hardware Handshaking

| PanelView Plus Port (DCE) | | Computer Port (DTE) | |
|---------------------------|-------|---------------------|--------|
| 9-pin Male | | 9-pin | 25-pin |
| 2 | → RXD | 2 | 3 |
| 3 | ← TXD | 3 | 2 |
| 5 | ↔ COM | 5 | 7 |

Controller Connections

Table 48 through Table 51 provides a summary of PanelView Plus 6 Compact connections to controllers and interface modules.

Table 48 - Communication Cables: PanelView Plus 6 Compact Terminals to SLC Controllers

| Protocol | PanelView Plus 6 Compact Port | SLC 500, 5/01, 5/02 CH1 RJ45 (DH-485) | SLC 5/03, 5/04, 5/05 CH0 (9-pin RS-232) (DF1 or DH-485) | SLC 5/03 CH1 (RJ45) (DH-485) | SLC 5/04 CH1 (DH+) | SLC 5/05 CH1 (ENET) |
|-------------|---|--|---|--|-----------------------|--|
| DF1 | RS-232 (DF1) port (9-pin) All terminals | — | 2711-NC13 (5 m/16 ft) 2711-NC14 (10 m/32 ft) | — | — | — |
| DH-485 | RS-232 (DH-485) port (9-pin) All terminals | Use AIC+ module (1761-NET-AIC) to connect to port 1 or 2 | 2711-NC13 (5 m/16 ft) 2711-NC14 (10 m/32 ft) | Use AIC+ module (1761-NET-AIC) to connect to port 1 or 2 | — | — |
| | DH-485 port 1000 terminals only Requires 2711P-RN6, 2711P-RN6K | 1761-CBL-AS03 (3 m/10 ft) 1761-CBL-AS09 (9 m/30 ft) | Use AIC+ module (1761-NET-AIC) to connect to port 3 | 1761-CBL-AS03 (3 m/10 ft) 1761-CBL-AS09 (9 m/30 ft) | — | — |
| EtherNet/IP | EtherNet/IP port All terminals 2711P-RN20 provides additional port - 1000 terminals only | — | Use 1761-NET-ENI module with Ethernet cable | — | — | 1585J-M type cable or 2711P-CBL-EX04 (4 m/14 ft) |

Table 49 - Communication Cables: PanelView Plus 6 Compact Terminals to PLC-5 and MicroLogix Controllers

| Protocol | PanelView Plus 6 Compact Port | PLC-5, PLC-5C, PLC-5E CH0 (25-pin RS-232) (DF1) | MicroLogix 1400, 1500LRP CH1/CH2 (9-pin RS-232) (DF1 or DH-485) | MicroLogix 1000, 1100, 1200, 1400, 1500LSP CH0 (8-pin Mini DIN) (DF1 or DH-485) | MicroLogix 1100, 1400 Ethernet |
|-------------|---|---|---|--|--|
| DF1 | RS-232 (DF1) port (9-pin) All terminals | 2711-NC13 (5 m/16 ft) 2711-NC14 (10 m/32 ft) (9-to-25 pin adapter required) | 2711-NC13 (5 m/16 ft) 2711-NC14 (10 m/32 ft) | 2711-NC21 (5 m/16 ft) 2711-NC22 (15 m/49 ft) ⁽¹⁾ | — |
| DH-485 | RS-232 (DH-485) port (9-pin) All terminals | — | 2711-NC13 (5 m/16 ft) 2711-NC14 (10 m/32 ft) | 2711-NC21 (5 m/16 ft) 2711-NC22 (15 m/49 ft) | — |
| | DH-485 port 1000 terminals only Requires 2711P-RN6, 2711P-RN6K | — | — | Use AIC+ module (1761-NET-AIC) to connect to port 3 | — |
| EtherNet/IP | EtherNet/IP port All terminals 2711P-RN20 provides additional port - 1000 terminals only | To PLC-5E with 1585J-M type cable or 2711P-CBL-EX04 (4 m/14 ft) | Use 1761-NET-ENI module with Ethernet cable | | 1585J-M type cable or 2711P-CBL-EX04 (4 m/14 ft) ⁽¹⁾ |

(1) The AIC+ module is recommended for isolation purposes when the terminal and controller are not on same power supply.

Table 50 - Communication Cables: PanelView Plus 6 Compact Terminals to Logix Controllers

| Protocol | PanelView Plus 6 Compact Port | ControlLogix CH0 (9-pin RS-232) (DF1) | CompactLogix CH0 (9-pin RS-232) (DF1 or DH-485) |
|-------------|---|---|---|
| DF1 | RS-232 (DF1) port (9-pin) All terminals | 2711-NC13 (5 m/16 ft) 2711-NC14 (10 m/32 ft) 2706-NC13 (3 m/10 ft) | 2711-NC13 (5 m/16 ft) 2711-NC14 (10 m/32 ft) 2706-NC13 (3 m/10 ft) |
| DH-485 | RS-232 (DH-485) port (9-pin) All terminals | — | 2711-NC13 (5 m/16 ft) 2711-NC14 (10 m/32 ft) 2706-NC13 (3 m/10 ft) |
| | DH-485 port 1000 terminals only Requires 2711P-RN6, 2711P-RN6K | — | Use AIC+ module (1761-NET-AIC) Connect to Port 3 |
| EtherNet/IP | EtherNet/IP port All terminals 2711P-RN20 provides additional port - 1000 terminals only | Use 1756-EN2T or 1756-ENBT module with 1585J-M type cable or 2711P-CBL-EX04 (4 m/14 ft) | To 1769-L35E, 1769-L23E, 1769-L32E, or 1768-ENBT module with 1585J-M type cable or 2711P-CBL-EX04 (4 m/14 ft) |

Table 51 - Communication Cables: PanelView Plus 6 Compact Terminals to Interface Modules

| Protocol | PanelView Plus 6 Comm Port | 1747-AIC | 1761-NET-AIC | | | 1761-NET-ENI |
|----------|---|---|---|--|--|---|
| | | | Port 1 (9-pin) | Port 2 (8-pin Mini DIN) | Port 3 (DH-485) | Port 2 (8-pin Mini DIN) |
| DF1 | RS-232 port (9-pin) All terminals | — | 2711-NC13 (5 m/16 ft) 2711-NC14 (10 m/32 ft) | 2711-NC21 (5 m/16 ft) 2711-NC22 (15 m/49 ft) Null modem required | — | 1761-CBL-AP00 (5 m) 1761-CBL-PM02 (2 m) 2711-CBL-PM05 (5 m) 2711-CBL-PM10 (10 m) |
| DH-485 | RS-232 port (9-pin) All terminals | — | 2711-NC13 (5 m/16 ft) 2711-NC14 (10 m/32 ft) | 2711-NC21 (5 m/16 ft) 2711-NC22 (15 m/49 ft) Null modem required | — | — |
| | DH-485 port 1000 terminals only Require 2711P-RN6, 2711P-RN6K | Direct connection to single AIC with Belden 9842 cable ⁽¹⁾ | — | — | Direct connection to single AIC+ with Belden 9842 cable ⁽¹⁾ | — |

(1) Use serial port on the PanelView Plus 6 Compact terminal with an AIC+ module for a DH-485 network solution.

Notes:

Firmware Upgrades

| Topic | Page |
|---|------|
| Terminal Firmware | 135 |
| Download Firmware Files | 136 |
| Firmware Upgrade Wizard | 136 |
| Upgrading Terminal Firmware from a Storage Device | 137 |
| Upgrade Terminal Firmware over the Network | 140 |

Terminal Firmware

Firmware components are packaged as execute-in-place (XIP) regions in a single System Code (SC) .img file. When the SC .img file is copied to the Virtual File System (VFS) on the terminal, the terminal's XIP regions are updated and the terminal restarts automatically. These firmware components are affected during an upgrade:

- FactoryTalk View Machine Edition Station software
- Communication protocols and drivers including Kepware drivers
- Windows fonts
- Windows CE components
- FactoryTalk components
- User extensions

A firmware upgrade does not affect these terminal components or settings:

- Windows registry
- File system including the FactoryTalk View Machine Edition application loaded in the terminal
- Network parameters including the network device name, DHCP-enabled and static IP addressing, speed, and duplex setting
- Display settings
- Screen saver configuration
- Touch-screen calibration

Download Firmware Files

Download the appropriate firmware installation package from the Rockwell Automation website. The package is named:

PVP6_<terminal family>_6.x-yyyymmdd.exe, where:

- <terminal family> is 400-600 or 1000
- 6.x is the FactoryTalk View ME software version contained in the package
- yyyymmdd is the date the package was created

This installation package contains the following:

- Firmware Upgrade Package (FUP) contains an autorun executable and the new firmware files.
- Firmware Upgrade Wizard (FUW), version 6.10 or later, is used to upgrade the terminal firmware by using the contents of the FUP.

Both the FUP and FUW are copied to your computer during the download.

Follow these steps to download firmware installation files to your computer.

1. Go to <http://www.rockwellautomation.com/support> and click the Firmware Updates link.
 2. Select Computers & Operator Interface, then PanelView Plus.
 3. Follow the instructions on the website to locate the firmware installation package for the appropriate PanelView Plus 6 terminals.
 4. Download the upgrade file (.exe) to a temporary folder on the same drive as the FactoryTalk View Machine Edition (ME) software.
 5. Run the upgrade file (.exe) installation procedure:
 - The FUW is installed in the FactoryTalk View ME folder.
 - The firmware upgrade package (.fup) file is installed into the folder specified during the installation procedure.
- TIP** The FUP name is ME_PVP6xX_6.x-yyyymmdd (1000) or ME_PVP6xA_6.x-yyyymmdd (400 and 600):
- yyyymmdd is the date the firmware package was created
 - 6.x is the version of ME contained in this package

You are now ready to run the FUW to upgrade terminal firmware from a USB drive or SD card or by using a network connection.

Firmware Upgrade Wizard

The Firmware Upgrade Wizard (FUW) is used to upgrade the terminal firmware. Two methods are provided for upgrading the firmware:

- Create a firmware upgrade card with the contents of the FUP file that you can then load in the terminal to upgrade the firmware.

The firmware upgrade card can be a USB drive or an SD card, catalog number 1784-SDx.

- Upgrade firmware in a terminal connected to a computer over a direct network connection. The network connection requires a computer running RSLinx Enterprise software, version 5.0 or later. In the RSLinx Enterprise software, you select the terminal you want to upgrade.

You can run the FUW from within FactoryTalk View Studio software or from the Programs menu on your computer:

- In FactoryTalk View Studio software, from the Tools menu, choose Firmware Upgrade Wizard.
- Choose Start>Programs>Rockwell Software>FactoryTalk View>Tools>ME Firmware Upgrade Wizard.

Upgrading Terminal Firmware from a Storage Device

Upgrading firmware from a storage device is a two-step process. First, you create a firmware upgrade card with the required firmware files. Secondly, you load the card in the target terminal to upgrade the firmware.

The firmware upgrade card can be a USB drive or an SD card.

Create a Firmware Upgrade Card

Follow these steps to copy firmware files to a USB drive or SD card.

1. Insert either a USB drive or an SD card into the appropriate slot on your computer.
2. Run the Firmware Upgrade Wizard:
 - In FactoryTalk View Studio software, from the Tools menu, choose Firmware Upgrade Wizard.
 - Choose Start>Programs>Rockwell Software>FactoryTalk View>Tools>ME Firmware Upgrade Wizard.
3. Follow these steps from the initial Firmware Upgrade Wizard dialog box.
 - a. Click Create firmware upgrade card.
 - b. Select the location of the firmware card by browsing to the root directory of the storage card loaded in your computer for example E:\.
The firmware files are copied to this location. You can also specify a folder on the hard drive.
 - c. From the Existing terminal type pull-down menu, choose a version v6.10 - v7.00, PanelView Plus 6 Compact terminal.
 - d. Click Next.

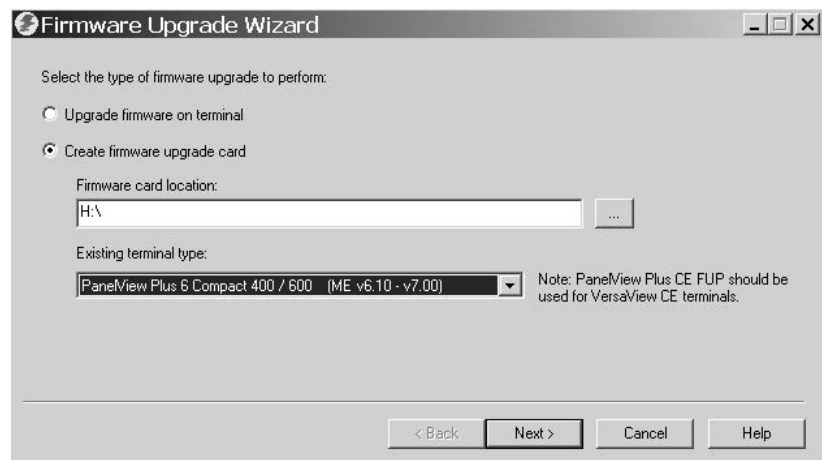

4. Follow these steps from this dialog box.
 - a. Browse to the location of the firmware source files on your computer, where the FUP was installed.
 - b. Choose the firmware revision for the upgrade.
 - c. Click Next.

It can take several seconds for the next dialog box to appear while the FUP is being retrieved.

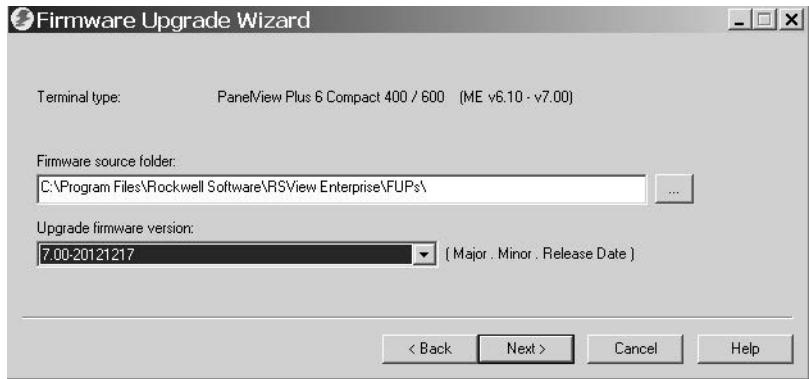

5. From this dialog box, optionally select the KEPServer drivers you want included in the firmware, then click Next.

Kepware drivers are already installed on the PanelView Plus 6 terminals.



The final dialog box summarizes your choices for creating the firmware upgrade card.

6. Click Finish to copy the firmware files to the firmware upgrade card.

A progress bar updates as files are copied to the USB drive or SD card.

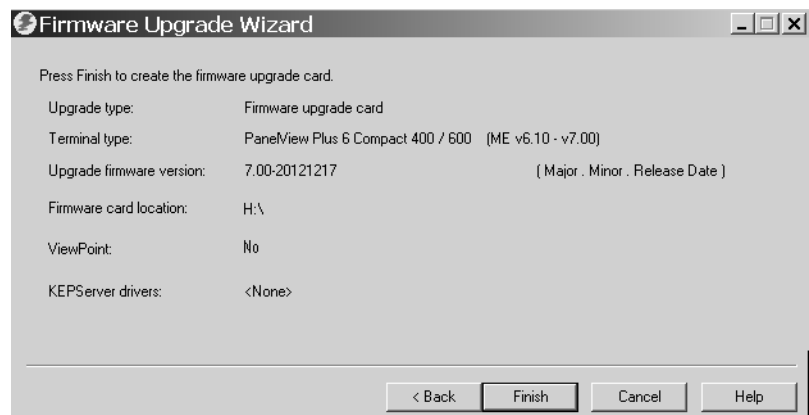

7. Click OK when the firmware upgrade completes successfully.

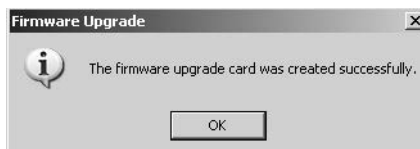

TIP If the firmware files were copied to the hard drive, copy the files to the root directory of the USB drive or SD card.

8. Remove the USB drive or SD card from your computer.
9. Proceed to the next section to use this firmware upgrade card to upgrade the terminal firmware.

Upgrade Terminal Firmware by Using Firmware Upgrade Card

Follows these steps to transfer firmware files from the USB drive or SD card to the terminal. This is the firmware upgrade card created in the previous section.

-
- IMPORTANT**
- Do not remove or accidently disconnect the USB drive or SD card while a firmware upgrade is in process. This could corrupt the firmware and make the terminal unstable.
 - Do not power off the terminal during a firmware upgrade.
 - USB hubs can produce unexpected behavior and are not recommended.
-

1. Insert the USB drive or SD card into the appropriate slot on your terminal.

The firmware upgrade automatically starts and displays this dialog box.

2. Press Upgrade or [F7] on the terminal to start the firmware upgrade.

The terminal restarts and displays a progress bar during the upgrade.

When the upgrade is complete, the terminal restarts, executing the new firmware.



3. Remove the USB drive or SD card from the terminal.

-
- IMPORTANT** If the firmware upgrade fails because of a power loss or the firmware upgrade card is inadvertently removed, you can restore the terminal to the factory default firmware. Refer to [Maintenance Operations on page 151](#) for details on how to restore the factory default settings.
-

Upgrade Terminal Firmware over the Network

You can upgrade firmware in a terminal connected to a computer over a direct network connection. The network connection requires a computer running the Firmware Upgrade Wizard (FUW) and RSLinx Enterprise software, version 5.0 or later.

RSLinx Enterprise software is required so that you can select the terminal on the network.

Follow these steps to copy firmware files to the terminal over a network by using RSLinx Enterprise software and Ethernet communication.

1. Run the Firmware Upgrade Wizard:
 - In FactoryTalk View Studio software, from the Tools menu, choose Firmware Upgrade Wizard.
 - Choose Start>Programs>Rockwell Software>FactoryTalk View>Tools>ME Firmware Upgrade Wizard.
2. Click Upgrade firmware on terminal and click Next.

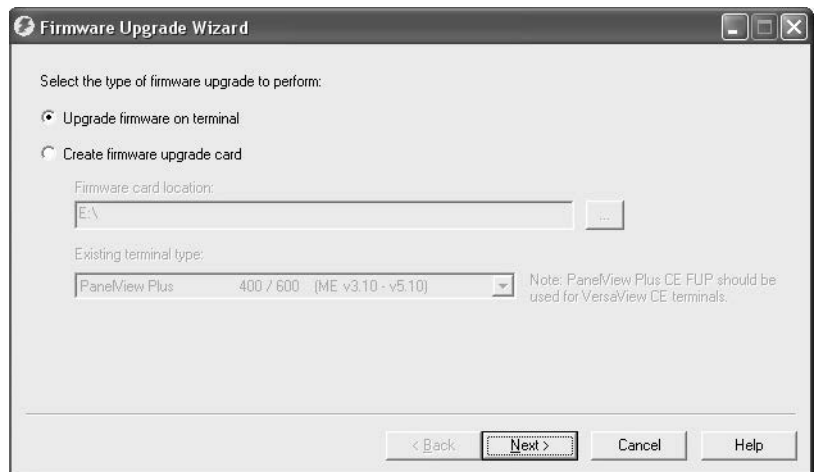

3. Click Yes to continue.

It is not necessary to back up files.

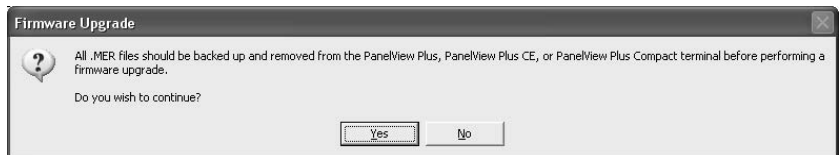

4. Click Network Connection (using RSLinx Enterprise) and click Next.

This is the only valid selection for PanelView Plus 6 terminals.

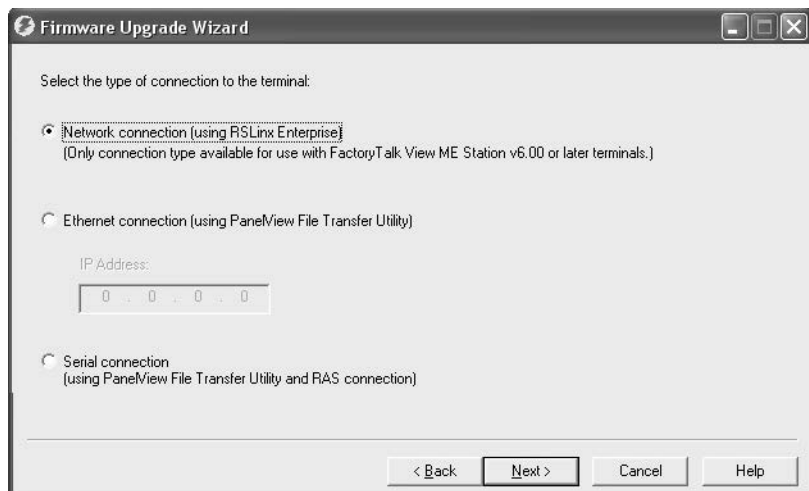

5. Navigate to and select the terminal to receive the firmware update, then click Next.

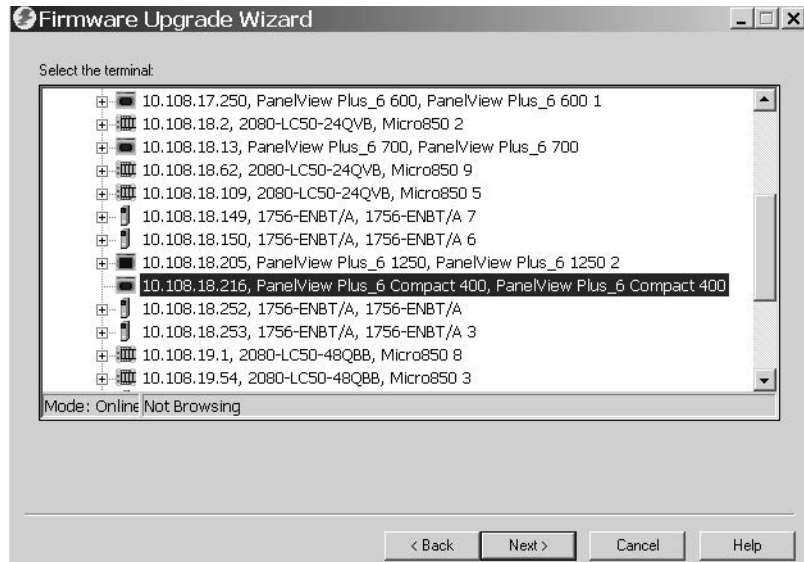

6. Follow these steps from this dialog box.
- Browse to the location of the firmware source files on your computer, where the FUP was installed.
The default location is shown.
 - Choose the version of the upgrade firmware from the pull-down menu.
 - Click Next.

It can take several seconds for the next dialog box to appear while the FUP is being retrieved.

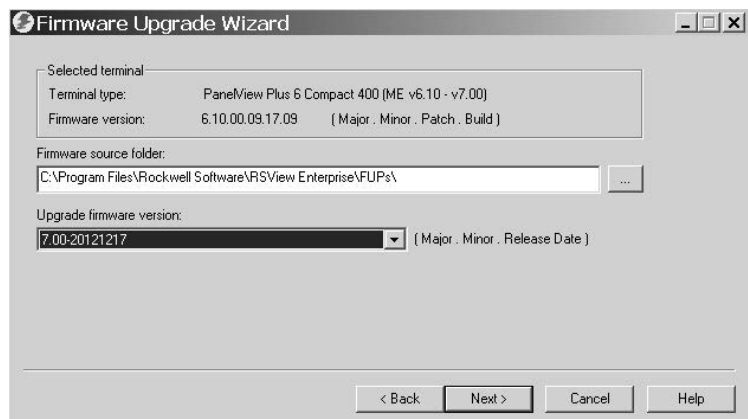

7. From this dialog box, optionally select the KEPServer drivers you want included in the firmware, then click Next.

Kepware drivers are already installed on the PanelView Plus 6 Compact terminals.

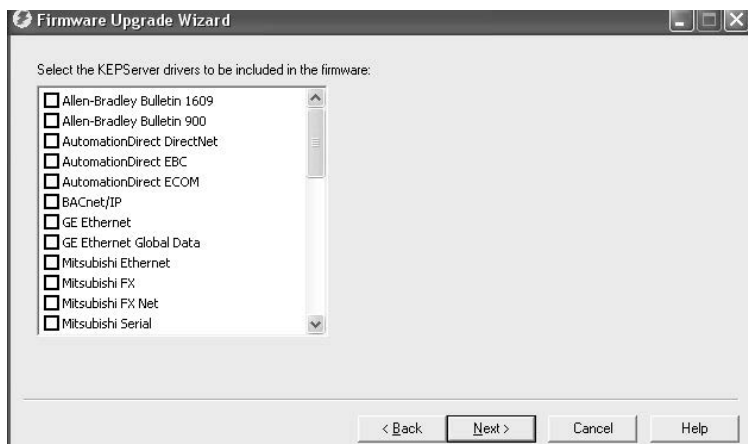

The final dialog box summarizes your choices for upgrading the terminal firmware.

8. Click Finish to update the firmware in the terminal.



9. Click Yes to continue with the update.

A progress bar updates as firmware files are copied to the terminal.

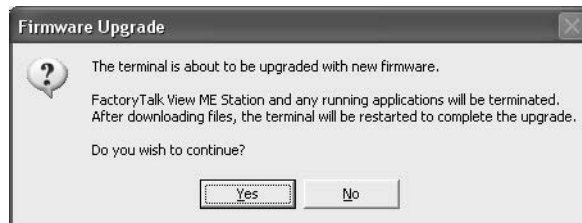

10. Click OK when the firmware upgrade is complete.

The terminal restarts, executing the new firmware.



IMPORTANT If the firmware upgrade fails because of a power loss or some other reason, you can restore the terminal to the factory default firmware. Refer to [Maintenance Operations on page 151](#) for details on how to restore the factory default settings.

Troubleshooting

| Topic | Page |
|----------------------------------|------|
| Status Indicators | 143 |
| Terminal Does Not Start Properly | 144 |
| Start-up Messages and Codes | 145 |
| Check Terminal Components | 147 |
| Ethernet Connection | 148 |
| Program Launcher ActiveX Control | 149 |
| Application Does Not Run | 149 |
| Configuration Mode Access | 149 |
| File System Errors | 150 |
| Advanced Diagnostics | 150 |
| Maintenance Operations | 151 |

Status Indicators

The terminal has two status indicators to isolate operating anomalies:

- COMM indicator (green) for communication status
- FAULT indicator (red) for hardware and firmware faults

The status indicators for the 400/600 terminals are under the battery cover.

Figure 13 - Status Indicators

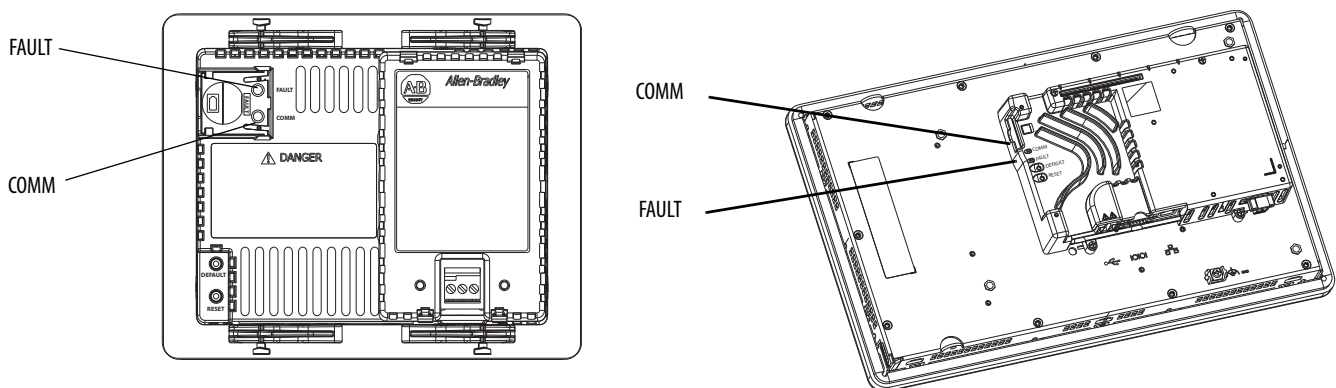

Terminal Does Not Start Properly

This section provides general troubleshooting information to assist you when trying to resolve problems during startup.

Check for Adequate Power

If a terminal does not receive adequate power, it can result in unpredictable behavior. Refer to [DC Power Connections on page 28](#) for power requirements.

Check Indicators at Startup

When the terminal starts the FAULT and COMM indicators flash on and off, then the COMM indicator flashes to signal progress during startup. When startup is complete, the COMM indicator remains on, and is controlled by the communication driver or application. The COMM indicator typically flashes when communication is active.

The indicators are off if the terminal is not receiving power. Check the power wiring and power supply.

If the indicators remain off, the power supply or logic board has failed. Check the power wiring and power supply:

- If the power is not within range, replace the power supply.
- If the power is within range, replace the terminal.

[Table 52](#) shows indicator states if the terminal powers on and stops during startup.

Table 52 - Indicator States if Terminal Stops During Startup

| FAULT (red) Indicator | COMM (green) Indicator | Description |
|-----------------------|------------------------|---|
| Flashing | Off | Recoverable firmware error. Last firmware download failed. Use the firmware upgrade wizard (FUW) to reload the firmware. |
| On | Off | Non-recoverable hardware fault with logic module: <ul style="list-style-type: none"> • For 400 and 600 terminals, replace the terminal. • For 1000 terminals, replace the logic module. |
| | Blinking | Non-recoverable hardware fault with display module: <ul style="list-style-type: none"> • For 400 and 600 terminals, replace the terminal. • For 1000 terminals, replace the display module. |

Check Start-up Messages and Codes

Refer to [Maintenance Operations on page 151](#) for a list of message states and error codes that can appear on the splash screen during startup.

Check Voltages and Temperatures

Check the battery voltage, processor temperature, and display temperature.

Table 53 - Checking Voltage and Temperature Conditions

| Check for These Conditions | Where | What to Do | |
|----------------------------|-----------------|---|---|
| Battery voltage | < 2.75V DC | <ul style="list-style-type: none"> From the terminal desktop: Refer to Monitors on page 82 From FactoryTalk View ME Station Configuration mode: Refer to View Terminal Information on page 64 | Replace the battery if needed. |
| Logic board temperature | >95 °C (203 °F) | <ul style="list-style-type: none"> From the terminal desktop: Refer to Monitors on page 82 | Check for obstructed airflow in the chassis and attempt to moderate the ambient temperatures within the enclosure and surroundings. |
| Display temperature | >55 °C (131 °F) | <ul style="list-style-type: none"> From terminal desktop: Refer to Temperatures on page 82 From FactoryTalk View ME Station Configuration mode: Refer to View Terminal Information on page 64 | |

Check the System Event Log

Check the system event log for errors and unexpected behaviors:

- From FactoryTalk View ME Station Configuration mode, press Terminal Settings>System Event Log. Refer to [View and Clear the System Event Log on page 64](#).
- From the control panel, open the Hardware Monitor and click the System Event Log tab. Refer to [System Event Log on page 81](#).

Start-up Messages and Codes

The splash screen reports actions and status conditions that occur during startup. This includes firmware and hardware revision information.

Figure 14 - Start-up Splash Screen

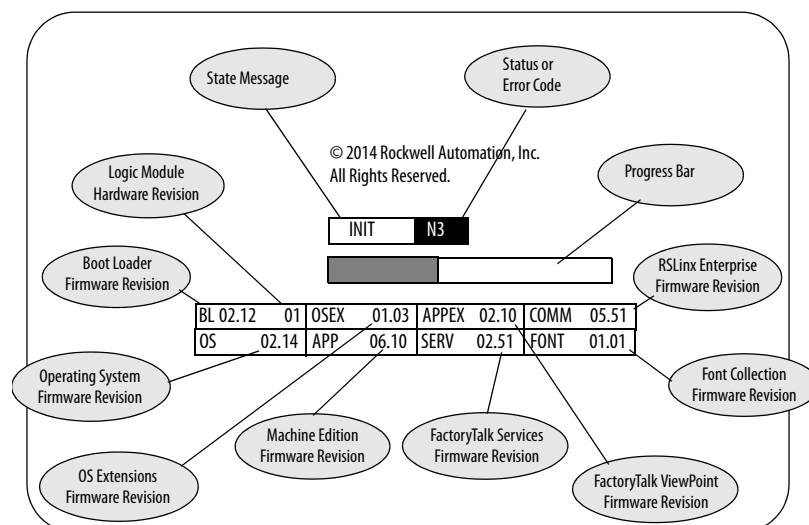

This table lists messages associated with each state and the corresponding status or error codes.

Table 54 - Start-up Messages and Codes

| State Message Description | State Message | Code | Recommended Action |
|---|---------------|---------|--|
| Common Start-up Messages | | | |
| Boot loader attempting PC connection via USB device | AutoTest | OA | Messages during this phase of startup are for information purposes only. |
| Boot loader loads firmware image into RAM | AutoTest | E6 | |
| Boot loader jumps to operating system | AutoTest | FF | |
| Operating system starts up | Boot | G0 | |
| Operating system registration and initialization | Init | H1 - JA | |
| Machine Edition registration and initialization | Init | K1 - MA | |
| Machine Edition load and execute | Init | ME | |
| Firmware Installation and Loading | | | |
| Load firmware image into RAM | Update | 1E | Messages during firmware installation and loading are for information purposes only. |
| Write firmware image to storage | Update | A5 | |
| Load factory-default firmware image into RAM | Restore | E6 | |
| Write factory-default firmware image to storage | Restore | A5 | |
| Restore factory-default configuration data | Restore | DC | |
| Firmware validation (CRC/format) failure | Fatal | 1E | A fatal error during firmware installation or loading is usually recoverable by doing one of the following: <ul style="list-style-type: none"> From the maintenance menu, reset the terminal. From the maintenance menu, restore the factory defaults. See page 153 for details on how to perform a restore. Re-install the firmware. |
| Firmware failed to validate compatibility index of a firmware region | Fatal | 1F | |
| Firmware update failure | Fatal | 0F | Refer to Access Maintenance Operations on page 152 for details on resetting terminal and restoring factory defaults. |
| Firmware write to storage failure | Fatal | A5 | |
| Firmware stored image verification failure | Fatal | D2 | |
| Invalid or missing OS firmware image | Fatal | FF | |
| Power on Self-test (POST) Failures | | | |
| Failed RAM | Fatal | 03 | A fatal error during POST is usually due to failed hardware: <ul style="list-style-type: none"> For failed RAM, replace the logic module (1000) or the terminal (400 and 600). For stuck key, stuck touch, and failed backlight, replace the display module. |
| Stuck key | Fatal | 31 | |
| Stuck touch | Fatal | 3A | |
| Failed backlight | Fatal | 3B | |
| Restore Operation Failures | | | |
| Failed to initialize restore operation | Fatal | R0 | A fatal error during a restore operation is usually recoverable by resetting the terminal from the maintenance menu. Refer to Access Maintenance Operations on page 152 for details on resetting the terminal. |
| Failed restore because of invalid header in .pvb file | Fatal | R1 | |
| Failed restore because of invalid header | Fatal | R2 | |
| Failed restore because of inability to write intermediate files to terminal | Fatal | R3 | |
| Failed restored because of corrupt .pvb file | Fatal | R4 | |
| Watch Dog | | | |
| Watch dog reset | Fatal | 02 | A watch dog reset is usually a momentary loss of control due to a software failure. Monitor this error for recurrence and remedial action. |

Check Terminal Components

This section provides tips on how to isolate anomalies with the display, touch screen, keypad, attached keyboard, or mouse. If you are unable to resolve the anomaly, replace the touch screen display module (1000) or the terminal (400-600).

Table 55 - Resolving Anomalies with the Touch Screen

| Symptom | Recommended Action |
|---|---|
| The display does not have a touch screen. | Check the catalog number of the unit. Verify that your display is a touch screen by looking at the label on the terminal. |
| The touch screen is not operating correctly. Touch input and dragging is inaccurate. | <p>Calibrate the touch screen:</p> <ul style="list-style-type: none"> In FactoryTalk View ME Station Configuration mode, press Terminal Settings>Input Devices>Touch Screen>Calibration. From the control panel on the terminal desktop, open the Touch dialog box and click the Calibration tab. <p>The calibration requires five screen touches. When the touches do not converge to a satisfactory calibration, you are asked for additional screen touches. The process continues until a valid calibration is performed.</p> <p>A touch screen that does not calibrate is not present or is not functioning properly. Replace the touch screen display module (1000) or the terminal (400-600).</p> |
| The screen cursor is not visible. | <p>Verify that the cursor is enabled:</p> <ul style="list-style-type: none"> In FactoryTalk View ME Station Configuration mode, press Terminal Settings>Display>Cursor. From the control panel on the terminal desktop, open Display and click the Advanced tab. |
| The touch screen does not accept touch input. | <p>Attach a USB mouse to check whether the issue is with the touch screen or the application:</p> <ul style="list-style-type: none"> If the mouse works, but the touch screen does not, then the touch driver or touch screen is not functioning properly. If both the mouse and the touch screen are not working, then it is an application issue. |

Table 56 - Resolving Anomalies with the Display

| Symptom | Recommended Action |
|---|--|
| The display is dim or unreadable. | <p>Check the brightness setting:</p> <ul style="list-style-type: none"> In FactoryTalk View ME Station Configuration mode, press Terminal Settings>Display>Display Intensity. From the control panel on the terminal desktop, open Display and click the Backlight tab. |
| The backlight is turning off or dimming the display unexpectedly. | <p>Check the screen saver settings:</p> <ul style="list-style-type: none"> In FactoryTalk View ME Station Configuration mode, press Terminal Settings>Display>Screen Saver. From the control panel on the terminal desktop, open Display and click the Screen Saver tab. |
| A start-up error appears during startup. | Record the message and check the start-up error messages table on page 145 . |

Table 57 - Resolving Anomalies with a Mouse

| Symptom | Recommended Action |
|--|---|
| The mouse is not operating correctly. | Check the USB cable and connection. Detach and then reattach the mouse. Restart or reset the terminal. |
| The screen cursor is not visible or the mouse settings need adjusting. | <p>Check if the screen cursor is disabled:</p> <ul style="list-style-type: none"> In FactoryTalk View ME Station Configuration mode, press Terminal Settings>Display>Cursor. From the control panel on the terminal desktop, open Display and click the Advanced tab. <p>Check the mouse setting:</p> <ul style="list-style-type: none"> In FactoryTalk View ME Station Configuration mode, press Terminal Settings>Input Devices>Mouse. From the control panel on the terminal desktop, open the Mouse dialog box. |
| The mouse is a USB composite device (keyboard + mouse). | <p>Attach a standalone USB mouse.</p> <p>For a list of compatible USB devices, go to the knowledgebase at the Rockwell Automation technical support site http://www.rockwellautomation.com/knowledgebase and search for ID 115072.</p> |
| The USB mouse does not work. | <p>The mouse can be noncompliant. Replace the USB mouse. Try a different model or manufacturer. If attaching a new mouse resolves the anomaly, then the old mouse was noncompliant.</p> <p>For a list of compatible USB devices, go to the knowledgebase at the Rockwell Automation technical support site http://www.rockwellautomation.com/knowledgebase and search for ID 115072.</p> |

Table 58 - Resolving Issues with a Keyboard

| Symptom | Recommended Action |
|--|---|
| The keyboard is not operating correctly | Check the USB cable and connector. Detach and reattach the keyboard. Verify a good connection. Restart or reset the terminal. |
| The keyboard is not accepting key input. | Use the keypad to check the key input: <ul style="list-style-type: none"> If the keypad works, but the keyboard does not, then the keyboard driver or keyboard is not working. If both the keypad and keyboard are not working, then the issue is probably an application failure. Issues with keyboard input can be the fault of the application: <ul style="list-style-type: none"> Press a key outside the application such as an edit box in the shell. If the keypad works outside the application, then the application is at fault. Press Ctrl+Esc simultaneously to open the Start menu, cursor to run, type numbers and viewable characters into the Run dialog box. |
| The keyboard is a USB composite device (keyboard + mouse). | Attach a standalone USB keyboard. |
| The keyboard does not work. | The keyboard can be noncompliant. Replace the USB keyboard. Try a different model or manufacturer. If a new keyboard resolves the issue, then the old keyboard was probably noncompliant. For a list of compatible USB devices, go to the knowledgebase at the Rockwell Automation technical support site http://www.rockwellautomation.com/knowledgebase and search for ID 115072. |

Ethernet Connection

This table provides tips on how to isolate Ethernet anomalies.

Table 59 - Resolve Ethernet Anomalies

| Action | Description |
|---|--|
| Check the status indicators at the Ethernet connection | <ul style="list-style-type: none"> Green indicates a communication link and is normally on. Yellow indicates data activity and is normally flashing. |
| Check cable connections and quality of cable | Check for the following: <ul style="list-style-type: none"> Cable crimping Ethernet hub/switch connection Uplink ports |
| Check the IP Address of the Built-in Ethernet Controller | <ul style="list-style-type: none"> In FactoryTalk View ME Station Configuration mode, press Terminal Settings>Networks then Communications>Network Connections>Network Adapters. From the control panel on the terminal desktop, open Network and Dial-up Connections. If DHCP is enabled, the device expects a valid IP address to be acquired within several seconds after startup. The TCP/IP protocol automatically assigns 169.254.nnn.nnn when it fails to acquire an IP address from the server. In general, an IP address that begins with 169 does not support a network connection. A bad Ethernet connection and the absence of a valid IP address are typically reported in a Communication error message box with the Winsock critical error 10065 - No route to host. |
| Check for conflicting IP addresses | If DHCP is not enabled, make sure the IP address of the terminal is not in conflict with the address of another device on the network. |
| Check the device name of the terminal | Devices on the network must not have the same host name: <ul style="list-style-type: none"> In FactoryTalk View ME Station, select Terminal Settings>Communications and Networks>Network Connections>Device Name. From the control panel on the terminal desktop, open the System applet and click the Device Name tab. |
| Contact your Network Administrator to check peer or server settings | The other side of the Ethernet connection can be an issue. |
| Check the requirements of network applications | Network applications can have specific requirements such as Proxy Settings for Internet Explorer and Ethernet Configuration for ActiveSync. |
| Check multi-homed devices | Multi-homed devices, more than one Ethernet node, can cause confusion and ambiguity. Keep the network connections as simple as possible. |
| From the desktop, use the network tools Ping.exe and Ipconfig.exe to diagnose issues with IP addresses and host devices | These network utilities are diagnostic tools: <ul style="list-style-type: none"> Ping is an Internet utility used to determine whether a particular IP address is reachable online by sending out a packet and waiting for a response. Ping is used to test and debug a network as well as see if a user or server is online. IPconfig is a Windows command line utility that manages the IP address assigned to the machine it is running in. It displays the computer's currently assigned IP, subnet mask, and default gateway addresses. |

Program Launcher ActiveX Control

If desktop access is restricted and you use the Program Launcher - ActiveX control to launch a file viewer, text editor, or PDF reader, the system locks up when you try to open a file.

To avoid this issue, associate a file with the application you are launching. The viewer, editor, or PDF reader automatically launches with the associated file.

Application Does Not Run

If a terminal application does not run, there can be an issue with the FactoryTalk View Machine Edition (ME) application:

- Verify that a start-up screen was configured and that the runtime file is a compatible version.
- Try to run the application manually. If the application runs manually, then the operating system can be starting up with an invalid shortcut path. Check the shortcuts in the Windows Startup folder.

\Windows\StartUp

Check the syntax of each shortcut path in the Startup folder and verify that a valid target application exists.

- Check that the application is not missing components or required DLLs. Remove and reload the application.

Configuration Mode Access

To access Configuration mode while an application is running, your FactoryTalk View ME application must contain a screen with a Goto Configuration Mode button. When the application is running, you can press this button to access Configuration mode.

If a running application does not contain a Goto Configuration Mode button, you can access Configuration mode during startup in one of two ways:

- Enter Safe mode from the general Maintenance screens. Refer to [page 151](#) for details.
- Detect a Safe mode request at startup by enabling this start-up option in the System dialog box of the control panel. Refer to [page 88](#) for details.

TIP If the terminal is configured to enter Configuration mode at startup and does not, then reload the firmware.

File System Errors

File system errors are rare as the internal file system is transaction safe. Always stop applications before removing power so that data is cleanly flushed out to the file system and the file system is brought to an orderly stop.

Do not remove the external USB or SD storage devices while writing to the device is in progress. Although the FactoryTalk View Machine Edition (ME) application runs from RAM, functions such as data logging, event logging, and historical trending, write to nonvolatile memory and must be stopped before removing power.

Advanced Diagnostics

Ping and ipconfig are valuable tools for network debugging along with some knowledge of IP and the Winsock error codes. Use these tools to help you debug your network:

- Try to ping the destination host.
- Check the destination address.
- Check whether you have a router configured in your network system (your WinSock implementation).
- Use the tracert command at the command prompt on the desktop to try and determine where the failure occurs along the route between your host and the destination host.

Other diagnostic tips that can help include these tools:

- Take advantage of alternate connectivity, such as mouse versus touch screen; keyboard versus keypad; serial communication; and Ethernet connections.
- Examine the folder `\Windows\DumpFiles` for crash logs when suspecting an application or operating system crash.

The crash dump file is viewable offline, on a workstation, by using common Windows development or debugging tools, for example, Visual Studio or WinDBG. At a minimum, the information in the crash dump file reveals the date and time of the exception, the exception type, the name of the offending process and the register state, including the program counter.

- Store Autorun.exe utilities on an SD card that can be easily run by inserting the card in the SD card slot of the terminal.
- Know useful keyboard shortcuts so that you can navigate around the system without a mouse or touch screen.
- Check the system event log in the Hardware Monitor control panel application or under Terminal Settings>System Event Log in FactoryTalk View ME Configuration mode. Look for error conditions or reasons that can cause unexpected behaviors or restarts.
- Check the configuration settings in the control panel on the terminal desktop or in FactoryTalk View ME Configuration mode.

Maintenance Operations

The terminal typically launches the Windows desktop or a FactoryTalk View ME application on startup. You can also start the system in Maintenance mode for diagnostics and repairs.

Table 60 - Maintenance Mode Operations

| Operation | Description |
|--|---|
| None | Exits Maintenance mode and continues with a normal restart. |
| Safe mode | Starts the system in Safe operating mode. This is a diagnostic mode with reduced functionality that lets you recovery from a software anomaly. In Safe mode, you can repair offending applications or changes that caused the anomaly. Important: FactoryTalk View ME Station software does not run the HMI .mer application on startup if one is loaded, but instead enters Configuration mode. The HMI application runs the next time the system is reset. |
| Reset terminal | Restores all user-accessible storage and configuration data on the terminal to its default state. The current firmware revision is retained. Important: All storage media is returned to its original state when purchased except for the firmware. The latest FactoryTalk View ME image is retained. All user data changes or additions are lost. |
| Restore factory defaults | Restores all storage media on the terminal to its initial factory default state, including firmware, registry, file system, and configuration data. Typically, this option is used to recover from a failed firmware upgrade. Important: All storage media is returned to its original state when purchased. All user-installed, firmware updates are removed. See Restore Factory Defaults on page 153 for details on how to perform a restore. |
| Display resolution (1000 terminals only) | Sets the display resolution at startup. If the system can't detect the resolution, you can choose the appropriate resolution by terminal model. <ul style="list-style-type: none"> • Auto - auto detects the display resolution. • VGA - sets the resolution to 640x480x16 for the 1000 terminals. The 400 and 600 displays are 320x240 QVGA. |

IMPORTANT Perform maintenance operations **in this order** to diagnose and repair operating problems with your terminal.

1. Safe mode – stops an application from starting automatically.
2. Reset terminal – removes user-installed applications, user-configuration changes, and user-accessible data.
3. Restore factory defaults – returns the terminal to its original, out-of-box state.

Access Maintenance Operations

Follow these steps to access Maintenance actions at startup.

TIP Terminals require an attached USB keyboard to navigate in Maintenance mode.

1. Insert a thin, nonconductive probe into the hole marked **DEFAULT** on the back of the logic module and press the switch.

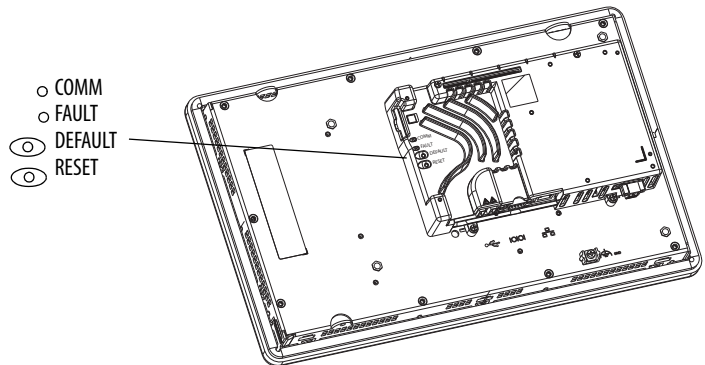
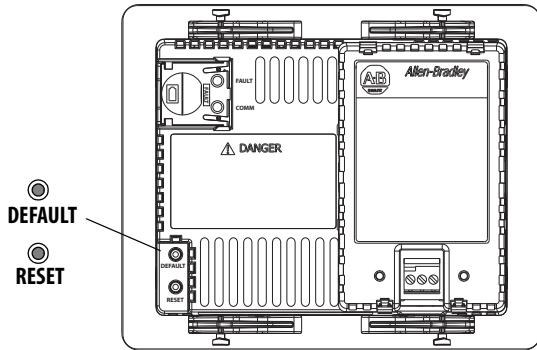

TIP To access this menu from a fault state, press the **RESET** switch, then press and hold the **DEFAULT** switch until you see the menu.

The terminal restarts in Maintenance mode with the display brightness set to 100%. See [Table 60 on page 151](#) for a description of maintenance operations.

Initial Maintenance Window

The version refers to the boot loader.

| | |
|---|--|
| default button pressed, please select maintenance options | |
| Maintenance Menu -- ver 0x.xx | |
| Reboot with selected options | Continue with this system boot. This option will continue booting with the options selected on the left. - IMPORTANT----- USB keyboard required! Press the RESET switch to ignore changes and continue system boot. |
| Special BOOT Action - None | |

TIP Use the keys at the bottom of the window to make selections.

2. Press the up and down arrow keys on the keypad or attached keyboard to move up and down the list of these maintenance options:
 - Reboot with selection options
 - Special BOOT Action

3. With an option selected, press the right or left arrow keys to cycle through the available operations or settings.

The result of each action is explained on the right.

Maintenance Window with Safe Mode Selected

The version refers to the boot loader.

| | |
|---|--|
| default button pressed, please select maintenance options | |
| Maintenance Menu -- ver 0x.xx | |
| Reboot with selected options | Selects the special BOOT action that will be executed during this system boot. - SAFE mode----- The system will start in the configuration mode of FactoryTalk View ME Station. - IMPORTANT----- FactoryTalk View ME Station will load at start up not the custom HMI application. The HMI application will start normally the next time the terminal is rebooted. |
| Special BOOT Action - SAFE Mode | |

4. Follow these steps, when done making selections.
 - a. Press the up arrow to return to 'Reboot with selected options'.
 - b. Press the Enter key to continue booting.

Restore Factory Defaults

To recover from a firmware update failure, for example, fatal code 0F, you need to restore your terminal to its out-of-box, factory default state.

Follow these steps to restore factory defaults from Maintenance mode.

TIP Terminals require an attached USB keyboard to navigate in Maintenance mode.

1. Press and hold the DEFAULT switch on the back of the logic module.
2. Press and release the RESET switch.
3. Release the DEFAULT switch.

The maintenance menu is displayed.

Initial Maintenance Window

| | |
|---|---|
| default button pressed, please select maintenance options | |
| Maintenance Menu -- ver 0x.xx | |
| Reboot with selected options | Continue with this system boot. This option will continue booting with the options selected on the left. - IMPORTANT----- USB keyboard required! Press the RESET switch to ignore changes and continue system boot. |
| Special BOOT Action - None | |

TIP Use the keys at the bottom of window to make selections.

4. Press the down arrow on the keyboard to select the following option:
Special BOOT Action -None
5. Press the right arrow three times to select the following option:
Special BOOT Action - Restore Factory Defaults

Maintenance Window with Restore Factory Defaults Selected

| | |
|---|--|
| default button pressed, please select maintenance options | |
| Maintenance Menu -- ver 0x.xx | |
| Reboot with selected options | Selects the special BOOT action that will be executed during this system boot. - Restore Factory Defaults ---- All storage media that exists on this terminal will be restored to a factory default state. - IMPORTANT----- All customer updates will be lost. |
| Special BOOT Action - Restore Factory Defaults | |

6. Press the up arrow to select 'Reboot with selected options'.
7. Press Enter on your keyboard to initiate the factory default restore process.

The terminal is returned to its out-of-box state, including the firmware, registry, file system, and storage areas. All user data is lost after the restore.

Fonts Resident on Terminal

True Type Fonts

[Table 61](#) lists true type fonts that are pre-installed on the terminals.

The default system font is Tahoma.

TIP The Arial Unicode MS font contains almost 50,000 characters and provides default language support for many non-Latin languages and scripts including Arabic, Hebrew, Vietnamese, Thai, Hindi (Devanagari), and other Indic languages. The font also includes Chinese, Japanese, and Korean (CJK) support.

You can load additional fonts on the system by copying the font files to the \Windows\Fonts folder on the terminal desktop. To access this folder, select the My Device icon on the terminal desktop or choose Start>Programs>Windows Explorer.

Table 61 - True Type Fonts

| True Type Fonts | File Name |
|-------------------------------|----------------|
| Arial Unicode MS version 1.01 | arialuni.ttf |
| Latin Fonts | |
| Arial | |
| Arial (Subset 1_30) | arial_1_30.ttf |
| Arial Black | arialk.ttf |
| Arial Bold | arialbd.ttf |
| Arial Bold Italic | arialbi.ttf |
| Arial Italic | ariali.ttf |
| Comic Sans MS | |
| Comic Sans MS | comic.ttf |
| Comic Sans MS Bold | comicbd.ttf |
| Courier New | |
| Courier New (Subset 1_30) | cour_1_30.ttf |
| Courier New Bold | courbd.ttf |
| Courier New Bold Italic | courbi.ttf |
| Courier New Italic | couri.ttf |
| Georgia | |
| Georgia | georgia.ttf |
| Georgia Bold | georgiab.ttf |
| Georgia Bold Italic | georgiaz.ttf |
| Georgia Italic | georgiai.ttf |
| Impact | impact.ttf |
| Kino | kino.ttf |

Table 61 - True Type Fonts

| True Type Fonts | File Name |
|--|-------------------------|
| Microsoft Logo | mslogo.ttf |
| Symbol | symbol.ttf |
| Tahoma | |
| Tahoma (Subset 1_07) | tahoma_1_07.ttf |
| Tahoma Bold | tahomabd.ttf |
| Times New Roman | |
| Times New Roman (Subset 1_30) | times_1_30.ttf |
| Times New Roman Bold | timesbd.ttf |
| Times New Roman Bold Italic | timesbi.ttf |
| Times New Roman Italic | timesi.ttf |
| Trebuchet MS | |
| Trebuchet MS | trebuc.ttf |
| Trebuchet MS Bold | trebucbd.ttf |
| Trebuchet MS Bold Italic | trebucbi.ttf |
| Trebuchet MS Italic | trebucit.ttf |
| Verdana | |
| Verdana | verdana.ttf |
| Verdana Bold | verdanab.ttf |
| Verdana Bold Italic | verdanaz.ttf |
| Verdana Italic | verdanai.ttf |
| Webdings | webdings.ttf |
| Wingding | wingding.ttf |
| PanelView Fonts | |
| PV 12 x 24, PV 12 x 8 | PV12x24.ttf, PV12x8.ttf |
| PV 16 x 24 | |
| PV 18 x 16, PV 18 x 8 | |
| PV 24 x 32 | |
| PV 32 x 40, PV 32 x 64 | |
| PV 4 x 6 | |
| PV 6 x 16, PV 6 x 24, PV 6 x 8, PV 6 x 9 | |
| PV 8 x 16, PV 8 x 20, PV 8 x 24 | |
| PV Double High | PVdouble_high.ttf |
| PV Double Wide | PVdouble_wide.ttf |
| PV Extra Large | PVextra_large.ttf |
| PV Large | PVlarge.ttf |
| PV Small | PVsmall.ttf |
| PV Tiny | PVtiny.ttf |
| PV Very Tiny | PVvery_tiny.ttf |
| East Asian Fonts | |
| Gulim version 2.21 - Korean | gulim.ttc |
| MS Gothic version 2.30 - Japanese | gulim.ttc |

A

AC power supply module 119
accessories 16
ActiveX controls 66
 Program Launcher 149
advanced diagnostics 89
alarm display, enable or disable 66
application
 checking integrity 62
 troubleshooting 149
application requirements 12

B

back up terminal image 78
backlight
 brightness 55, 84
backup and restore 78
battery
 replacement 117
battery voltage 64
 control panel 82
 FactoryTalk View ME 64
bezel replacement 112
button styles 88

C

catalog numbers 12
clean display 123
closed system 15, 88
communication
 controller address 48
 Ethernet 48, 127
 KEPServer 46, 100
 RSLinx Enterprise 46
 serial 129
communication module
 installation 108
 replacement 109
control panel 77
 advanced diagnostics 89
 backup and restore 78
 battery voltage 82
 battery warning 87
 cursor 85
 desktop background 84
 display temperature 82
 input panel 76
 keyboard and keypad settings 83
 logo updates 86
 network servers 91
 print set up 101
 processor temperature 82
 running processes 81
 screen saver 85
 system event log 81
 touch screen calibration 83
 user accounts 90

copying files

 applications 54
 font files 54

cursor

 control panel 85
 FactoryTalk View ME 56

D**date and time** 67**DC power**

 connection 30
 earth ground 29
 external power supply 28

default switch 13, 152**deleting files**

 applications 52
 font files 52
 log files 52

desktop access 15, 88

 disable 43
 enable 42
 factory default state 15
 open versus closed 15
 reset password 44
 set password 44

device name 51**diagnostics**

 in FactoryTalk View ME 63

dimensions

 panel cutout 20
 product 21

display module 123**display settings**

 control panel 84
 FactoryTalk View ME 55
 resolution 151

display temperature

 control panel 82, 84

E**earth ground**

 DC power 29

enable desktop access 42**error messages** 146**Ethernet**

 cable 127
 communication 127
 connector 127
 connector pinout 127
 DHCP 49
 IP address 48
 link speed 50
 name server addresses 50
 status indicators 127
 troubleshooting 148

external power supply 28

F

- factory defaults** 151
- FactoryTalk View ME** 46, 64, 66
 - alarm display enable or disable 66
 - battery voltage 65
 - check file integrity 62
 - configuration mode 33
 - cursor 56
 - desktop access 42
 - diagnostics 62
 - display settings 55
 - Ethernet settings 48
 - font linking 72
 - input devices 57
 - IP address 48
 - keyboard or keypad settings 57
 - loading application 38
 - print options 60
 - processor temperature 65
 - regional settings 69–71
 - running application 38
 - screen saver 56
 - startup options 39
 - string entry 57
 - system event log 64
 - system information 66
 - terminal device name 51
 - terminal settings 36
 - time and date operations 66
 - touch screen calibration 58
 - transferring files 52
- file server** 75
 - configuration 100
- finger or glove-finger operation** 14
- firmware revisions** 66
 - control panel 87
 - FactoryTalk View ME 66
- firmware upgrades**
 - firmware upgrade wizard 136
 - over network 140
 - recover from failure 146, 153
 - using storage device 137
- fonts** 155
 - linking 72
- ftp server** 75
 - anonymous login example 98
 - configuration 97
 - connection requiring authentication 99
 - security 97

H

- hazardous locations** 18

I

- IGMP Protocol** 128
- input devices**
 - control panel 83
 - FactoryTalk View ME 57
 - mouse 57, 59
- input panel** 76

installation

- AC power supply module 119
- backlight 114
- battery 117
- bezel 112
- hazardous locations 18
- mounting 700 to 1500 terminals terminal 24
- mounting clearances 20
- mounting terminal in panel 22
- panel cutout dimensions 20
- panel guidelines 20
- product dimensions 21
- product label 122
- USB peripheral devices 19

Internet Group Management Protocol (IGMP)
128**K**

- KEPServer configuration** 100
- keyboard and keypad settings**
 - control panel 83
 - FactoryTalk View ME 57
 - troubleshooting 148

L

- languages** 69
- loading application** 38
- logic module**
 - replacement 108
- logo manager** 86
- logs**
 - application files 62
 - runtime files 62
 - system event log 64, 81

M

- maintenance operations**
 - accessing 152
 - default switch 152
 - factory defaults 151
 - resolution 151
 - safe mode 151
- memory usage** 64
 - control panel 82
 - FactoryTalk View ME 64
- mounting** 24
- mounting clearances** 20
- mounting terminal** 22
- mouse** 57, 59

N

- network servers** 91
 - enabling or disabling 91
 - file 100
 - ftp 97
 - vnc 92
 - web 96

O

- open system** 15
- open versus closed system** 88
- operating system** 12, 73
 - application support 74
 - network support 75
 - scripting support 74
 - server support 75
- operator input** 14

P

- panel cutout dimensions** 20
- panel guidelines** 20
- PanelView Plus 6 Compact overview**
 - overview of terminals 11
- password**
 - desktop access 44
 - reset password 44
 - set password 44
- PDF reader** 104
- power connections** 13
 - DC power 28
 - terminal block 26
- print setup**
 - control panel 101
 - for alarms 60
 - for diagnostic messages 60
 - for displays 60
- processor temperature** 64
 - control panel 82
 - FactoryTalk View ME 64
- product selections** 12
- Program Launcher ActiveX Control** 149

R

- regional settings**
 - FactoryTalk View ME 69-71
- reset terminal** 31
 - from maintenance window 151
 - reset switch 32
- restart terminal** 31
- restore factory defaults** 151, 153
- restore terminal image** 78
- RS-232 serial port** 13
- RSLink communication settings** 46
- running application** 38

S

- safe mode** 88, 151
- screen saver**
 - control panel 85
 - FactoryTalk View ME 56

SD card

- card slot 13
- loading 122
- slot 122
- using to back up and restore image 78

serial communication

- DF1 129
- DH485 129
- null modem cable 130
- ports 129
- transferring applications 129

server support 75**servers**

- enabling or disabling 91
- file 100
- ftp 97
- VNC 91, 92
- web 96

Simple Network Management Protocol (SNMP) 128**software support** 12**startup**

- anomalies 149
- error messages 146
- initial 31

startup options 15

- advanced diagnostics 89
- changing button style 88
- detecting safe mode 88
- disable configuration mode 39
- disable FactoryTalk View ME Station 39
- displaying battery warning 87
- displaying watchdog errors 89
- FactoryTalk View ME 39
- open or closed system 88
- run configuration mode 39, 40
- run loaded application 41

status indicators 13**string entry** 57**stylus** 14**system event log**

- control panel 81
- FactoryTalk View ME 64

system information

- control panel 87
- FactoryTalk View ME 66

T**taskbar** 76**temperature** 82

- processor 64, 82

terminal

- features 13

terminal settings 36

- date 67
- diagnostics 63
- long date format 71
- short date format 71
- system event log 64
- time 67
- time format 70
- time zone 68

time and date operations

- FactoryTalk View ME 66

touch screen calibration

- control panel 83
- FactoryTalk View ME 58

transferring files 54**troubleshooting**

- accessing configuration mode 149
- advanced 150
- change display resolution 151
- Ethernet connection 148
- general 144
- indicators 143
- keyboard 148
- maintenance operations 151
- mouse 147
- power 144
- restore factory defaults 151
- start in safe mode 151

U**UPnP server** 75**USB drive**

- using to back up and restore image 79

USB peripheral devices 19**USB ports** 13, 126

- connector pinouts 126
- device port 13, 126
- host port 13, 126
- installation 126
- peripheral devices 126

user accounts 90**V****ViewPoint** 75**VNC server** 75

- client viewers 92
- configuration 92
- control and view connection example 94
- control operations 92
- security 92
- view-only connection example 93
- view-only operations 92

W**watchdog errors** 89**web server** 75

- configuration 96

Windows Explorer 76**Windows operating system** 73**wiring and safety guidelines** 18, 125

Rockwell Automation Support

Rockwell Automation provides technical information on the Web to assist you in using its products.

At <http://www.rockwellautomation.com/support> you can find technical and application notes, sample code, and links to software service packs. You can also visit our Support Center at <https://rockwellautomation.custhelp.com/> for software updates, support chats and forums, technical information, FAQs, and to sign up for product notification updates.

In addition, we offer multiple support programs for installation, configuration, and troubleshooting. For more information, contact your local distributor or Rockwell Automation representative, or visit <http://www.rockwellautomation.com/services/online-phone>.

Installation Assistance

If you experience a problem within the first 24 hours of installation, review the information that is contained in this manual. You can contact Customer Support for initial help in getting your product up and running.

| | |
|---------------------------------|--|
| United States or Canada | 1.440.646.3434 |
| Outside United States or Canada | Use the Worldwide Locator at http://www.rockwellautomation.com/rockwellautomation/support/overview.page , or contact your local Rockwell Automation representative. |

New Product Satisfaction Return

Rockwell Automation tests all of its products to help ensure that they are fully operational when shipped from the manufacturing facility. However, if your product is not functioning and needs to be returned, follow these procedures.

| | |
|-----------------------|---|
| United States | Contact your distributor. You must provide a Customer Support case number (call the phone number above to obtain one) to your distributor to complete the return process. |
| Outside United States | Please contact your local Rockwell Automation representative for the return procedure. |

Documentation Feedback

Your comments will help us serve your documentation needs better. If you have any suggestions on how to improve this document, complete this form, publication [RA-DU002](#), available at <http://www.rockwellautomation.com/literature/>.

Rockwell Automation maintains current product environmental information on its website at <http://www.rockwellautomation.com/rockwellautomation/about-us/sustainability-ethics/product-environmental-compliance.page>.

Rockwell Otomasyon Ticaret A.Ş., Kar Plaza İş Merkezi E Blok Kat:6 34752 İçerenköy, İstanbul, Tel: +90 (216) 5698400

www.rockwellautomation.com

Power, Control and Information Solutions Headquarters

Americas: Rockwell Automation, 1201 South Second Street, Milwaukee, WI 53204-2496 USA, Tel: (1) 414.382.2000, Fax: (1) 414.382.4444
Europe/Middle East/Africa: Rockwell Automation NV, Pegasus Park, De Kleetlaan 12a, 1831 Diegem, Belgium, Tel: (32) 2 663 0600, Fax: (32) 2 663 0640
Asia Pacific: Rockwell Automation, Level 14, Core F, Cyberport 3, 100 Cyberport Road, Hong Kong, Tel: (852) 2887 4788, Fax: (852) 2508 1846

Publication 2711PC-UM002C-EN-P - March 2015

Supersedes Publication 2711PC-UM002B-EN-P - April 2014

Copyright © 2015 Rockwell Automation, Inc. All rights reserved. Printed in the U.S.A.